



NR Line
Product/Manual Catalog

Dentium
For Dentists By Dentists

Contents

Introduction

S.L.A. Surface	05
NR Line Characteristics	06
NR Line Color Coding by Diameter	07
NR Line Fixture	08

Surgical Components

Cover Screw	10
Healing Abutment	11
IOS Healing Abutment	13

Prosthetic Procedure 1

Dual Abutment - Abutment Level Impression	14
Dual Abutment [Square]	15
Dual Abutment [Round]	17
Abutment Level Impression Components	19

Prosthetic Procedure 2

Dual / Dual Milling / Angled / Metal-Casting / Temporary Abutment - Fixture Level Impression	20
Fixture Level Impression Components	21
Dual Milling Abutment	25
Angled Abutment [15°]	27
Angled Abutment [25°]	29
Metal Casting Abutment	30
Temporary Abutment	31

Prosthetic Procedure 3

Screw Abutment - Abutment Level Impression	33
Screw Abutment	34
Angled Screw Abutment	35
Screw Abutment Impression Components	36

Prosthetic Procedure 4

Mini Ball Attachment - Abutment Level Impression	38
Mini Ball Attachment	39
Angled Mini Ball Attachment	40
Magnetic Attachment	41

Instruments

Surgical Kit	42
Stopper Kit	43
Prosthetic Kit	44
Drill	45
Instrument	47
Prosthetic and Laboratory Instrument	50

Surgical Manual	52
Prosthesis Manual	61



S.L.A. Surface

S.L.A. (Sandblasting with Large grit and Acid etching)

- Higher bone-to-implant contact
- Faster bone formation on the surface

In vivo test

NR Line Characteristics

Abutment screw

- $\varnothing 1.9$ hole size for occlusion

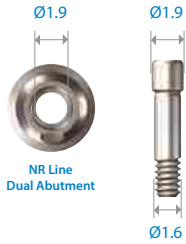

Narrow, but strong

- Body $\varnothing 3.1$ fixture is very useful for narrow ridge
- Good for high occlusal stress

Extended thread design

- Extended thread design helps increase the initial stability

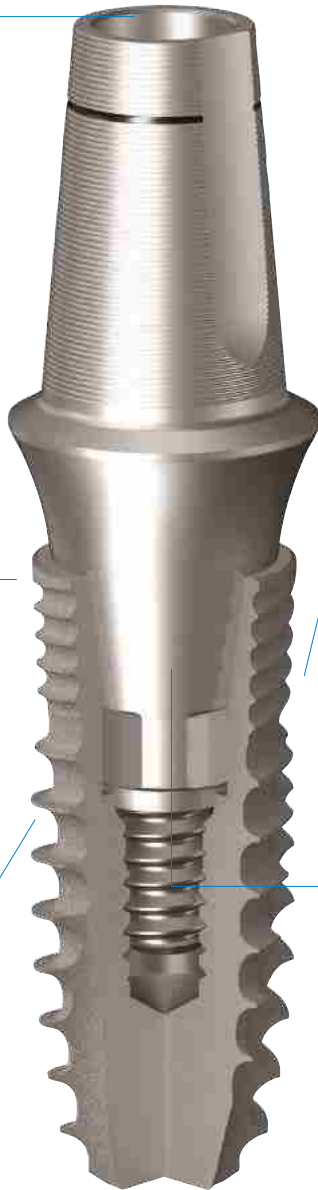
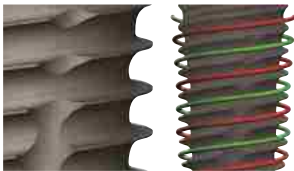

Simple GBR

- Minimize bone and gingival resorption

Firm & stable connection (Internal 10° taper & square shape)

- Less screw, abutment & fixture fracture







- 10° taper & square shape between implant and abutment interface ensures tight sealing
- Square connection

NR Line Color Coding by Diameter

Color Coding by Diameter

· Cover screw is not included in the package.

Unit: mm

Cap Color							
		Yellow	Yellow	Green	Blue	Red	Red
Fixture NR Line (Mount Free)							
	A Platform Diameter	3.2	3.6	3.6	4.3	5.0	6.0
	B Body Diameter	3.1	3.1	3.6	4.3	5.0	5.0
	C L: 7B Bevel Height		2.0	2.0	2.0	2.0	2.0
	C L: 7, 9, 11, 13 Bevel Height	0.03	1.0	0.05	0.25	0.45	0.70
Selection Guideline		Anterior	Anterior	Premolar	Molar	Molar	Molar

NR Line Fixture

Unit: mm, Scale 1 : 1.5

Body Ø 3.1 | Platform Ø 3.2

L	Art. No.
7	GFX 30 07 S
9	GFX 30 09 S
11	GFX 30 11 S
13	GFX 30 13 S

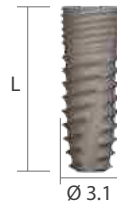

Body Ø 3.1 | Platform Ø 3.6

L	Art. No.
7	GFX 30 07 B
7	GFX 30 07
9	GFX 30 09
11	GFX 30 11
13	GFX 30 13



Body Ø 3.6 | Platform Ø 3.6

L	Art. No.
7	GFX 36 07 BS
7	GFX 36 07 S
9	GFX 36 09 S
11	GFX 36 11 S
13	GFX 36 13 S



※ Note: To prevent damage to the Implant driver or fixture, do not over torque during fixture insertion

NR Line Fixture

Unit: mm, Scale 1 : 1.5

Body Ø 4.3 | Platform Ø 4.3

L	Art. No.
7	GFX 43 07 BS
7	GFX 43 07 S
9	GFX 43 09 S
11	GFX 43 11 S
13	GFX 43 13 S

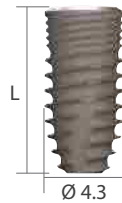

07

07

09

11

13



Body Ø 5.0 | Platform Ø 5.0

L	Art. No.
7	GFX 50 07 BS
7	GFX 50 07 S
9	GFX 50 09 S
11	GFX 50 11 S
13	GFX 50 13 S



07

07

09

11

13



Body Ø 5.0 | Platform Ø 6.0

L	Art. No.
7	GFX 50 07 BW
7	GFX 50 07 W
9	GFX 50 09 W
11	GFX 50 11 W
13	GFX 50 13 W

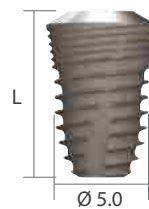

07

07

09

11

13



※ Note: To prevent damage to the Implant driver or fixture, do not over torque during fixture insertion

Cover Screw

Unit: mm, Scale 1 : 1.5



GCS36 and GFX3609S

Cover Screw

Application (Body Ø)	Art. No.
Ø3.1S	GCS 30
Ø3.1 / Ø3.6S / Ø4.3S / Ø5.0S / Ø5.0W	GCS 36

Ø3.1



Ø3.5



※ Square driver: Use no more than 5N-cm torque when screwing a cover screw to a fixture
If square is worn, slot on the head of the product can be used to rotate it

Healing Abutment

• Single use only

Unit: mm, Scale 1 : 1.5



GHAB433545 and GFX3609S

Diameter Ø3.1 / Ø3.6

G/H	Art. No.
3.5	GBHA 31 35
0.5	GBHA 36 05
2.0	GBHA 36 20



Diameter Ø3.7

G/H	H	Art. No.
0.5	3.0	GHAB 37 05 30
1.5	2.5	GHAB 37 15 25
3.5	4.5	GHAB 37 35 45
5.5	6.5	GHAB 37 55 65

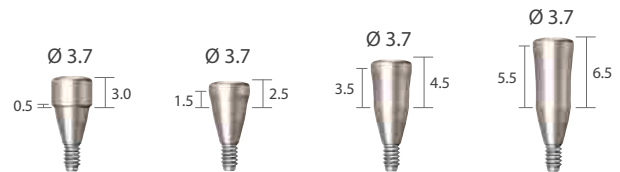

Diameter Ø 4.3

G/H	H	Art. No.
0.5	3.0	GHAB 43 05 30
1.5	2.5	GHAB 43 15 25
3.5	4.5	GHAB 43 35 45
5.5	6.5	GHAB 43 55 65

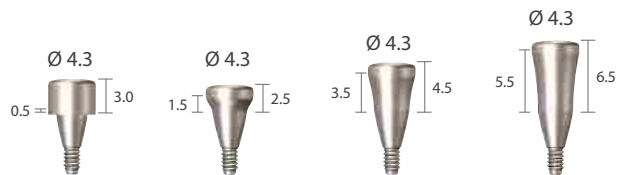

Diameter Ø 5.5

G/H	H	Art. No.
0.5	3.0	GHAB 55 05 30
1.5	2.5	GHAB 55 15 25
3.5	4.5	GHAB 55 35 45
5.5	6.5	GHAB 55 55 65

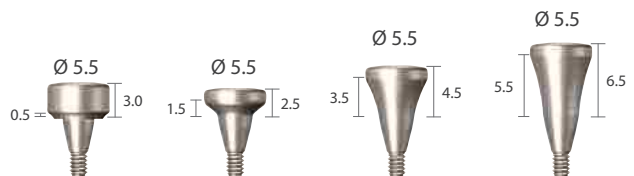

※ Square driver: Use no more than 5N-cm torque when screwing a cover screw to a fixture
If square is worn, slot on the head of the product can be used to rotate it

Healing Abutment

• Single use only

Unit: mm, Scale 1 : 1.5

Diameter Ø 6.5

G/H	H	Art. No.
0.5	3.0	GHAB 65 05 30
1.5	2.5	GHAB 65 15 25
3.5	4.5	GHAB 65 35 45
5.5	6.5	GHAB 65 55 65

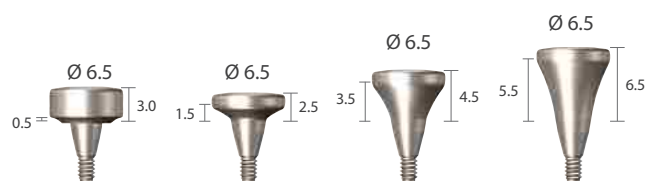

Diameter Ø 7.5

G/H	H	Art. No.
4.0	4.0	GHAB 75 40 40



Diameter Ø 8.5

G/H	H	Art. No.
4.0	4.0	GHAB 85 40 40

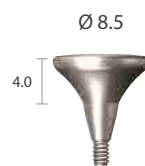

Diameter Ø 9.5

G/H	H	Art. No.
4.0	4.0	GHAB 95 40 40

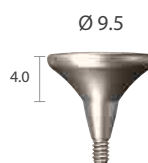

※ Square driver: Use no more than 5N-cm torque when screwing a cover screw to a fixture
If square is worn, slot on the head of the product can be used to rotate it

IOS Healing Abutment

• Single use only

Unit: mm, Scale 1 : 1.5

Diameter Ø 4.0

Diameter	G/H	Type	Art. No.
Ø 4.0	6.0	Square	GIHAB 40 06 S
	6.0	Round	GIHAB 40 06 R
	8.0	Square	GIHAB 40 08 S
	8.0	Round	GIHAB 40 08 R
	10.0	Square	GIHAB 40 10 S
	10.0	Round	GIHAB 40 10 R

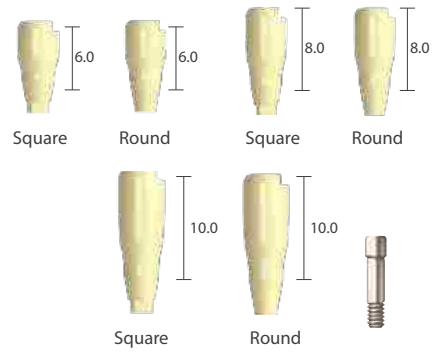

Diameter Ø 5.0

Diameter	G/H	Type	Art. No.
Ø 5.0	6.0	Square	GIHAB 50 06 S
	6.0	Round	GIHAB 50 06 R
	8.0	Square	GIHAB 50 08 S
	8.0	Round	GIHAB 50 08 R
	10.0	Square	GIHAB 50 10 S
	10.0	Round	GIHAB 50 10 R

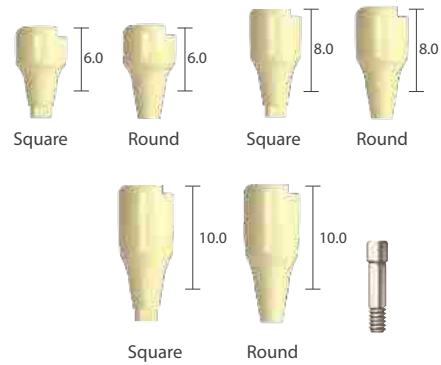

Diameter Ø 6.0

Diameter	G/H	Type	Art. No.
Ø 6.0	6.0	Square	GIHAB 60 06 S
	6.0	Round	GIHAB 60 06 R
	8.0	Square	GIHAB 60 08 S
	8.0	Round	GIHAB 60 08 R
	10.0	Square	GIHAB 60 10 S
	10.0	Round	GIHAB 60 10 R

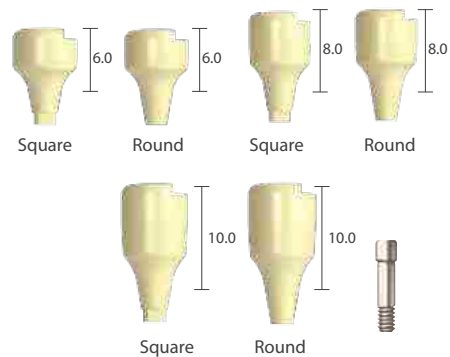

※ Square driver: Use no more than 5N-cm torque when screwing a cover screw to a fixture
If square is worn, slot on the head of the product can be used to rotate it

Prosthetic Procedure 1

Impression Technique and Restoration Selection

Dual Abutment

Abutment Level Impression

Closed Tray Technique



Dual Abutment

Square / Round
Ø3.7 / Ø4.3 / Ø5.5 / Ø6.5

Page 14, 15, 16, 17



Impression Coping

(Burn-Out Cylinder, Comfort Cap, Abutment Holder)

Ø3.7 / Ø4.3 / Ø5.5 / Ø6.5

Page 18



Comfort Cap

Ø3.7 / Ø4.3 / Ø5.5 / Ø6.5

Page 18



Analog

Ø3.7 / Ø4.3 / Ø5.5 / Ø6.5

Page 18

Modification

Cemented Restoration

Dual Abutment [Square]

• Abutment screw is included

Unit: mm, Scale 1 : 1.5

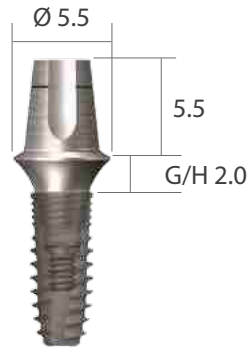

GDAB5520AS and GFX3609S

Diameter $\varnothing 3.7$ | Square

G/H	Art. No.
0.5	GDAB 37 05 AS(H)
1.0	GDAB 37 10 AS(H)
2.0	GDAB 37 20 AS(H)
3.0	GDAB 37 30 AS(H)
4.0	GDAB 37 40 AS(H)
5.0	GDAB 37 50 AS(H)



Diameter $\varnothing 4.3$ | Square

G/H	Art. No.
0.5	GDAB 43 05 BAS(H)
1.0	GDAB 43 10 AS(H)
2.0	GDAB 43 20 AS(H)
3.0	GDAB 43 30 AS(H)
4.0	GDAB 43 40 AS(H)
5.0	GDAB 43 50 AS(H)



※ Note: It is recommended to keep the torque level at 20 N-cm to tighten the dual abutment with fixture

Dual Abutment [Square]

• Abutment screw is included

Unit: mm, Scale 1 : 1.5

Diameter Ø5.5 | Square

G/H	Art. No.
0.5	GDAB 55 05 BAS(H)
1.0	GDAB 55 10 AS(H)
2.0	GDAB 55 20 AS(H)
3.0	GDAB 55 30 AS(H)
4.0	GDAB 55 40 AS(H)
5.0	GDAB 55 50 AS(H)

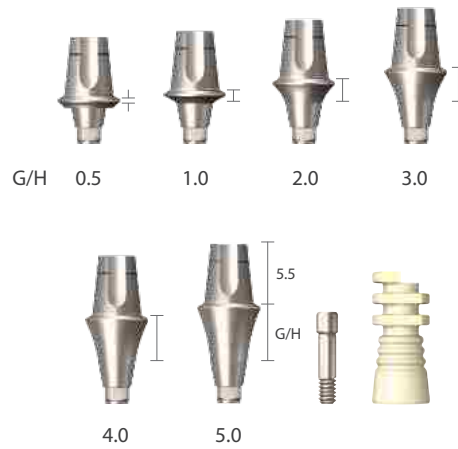

Diameter Ø6.5 | Square

G/H	Art. No.
0.5	GDAB 65 05 BAS(H)
1.0	GDAB 65 10 AS(H)
2.0	GDAB 65 20 AS(H)
3.0	GDAB 65 30 AS(H)
4.0	GDAB 65 40 AS(H)
5.0	GDAB 65 50 AS(H)

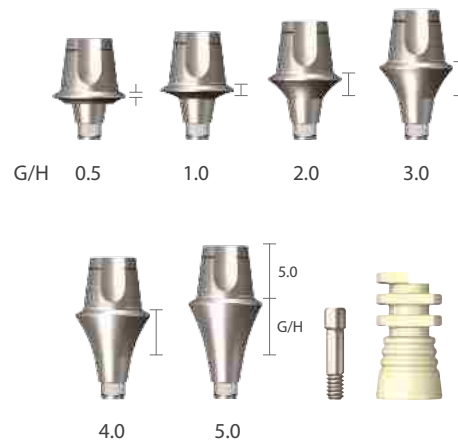

※ Note: It is recommended to keep the torque level at 20 N·cm to tighten the dual abutment with fixture

Dual Abutment [Round]

• Abutment screw is included

Unit: mm, Scale 1 : 1.5



GDAB5220AR and GFX3609S

Diameter Ø3.7 | Round

G/H	Art. No.
0.5	GDAB 37 05 AR(H)
1.0	GDAB 37 10 AR(H)
2.0	GDAB 37 20 AR(H)
3.0	GDAB 37 30 AR(H)
4.0	GDAB 37 40 AR(H)
5.0	GDAB 37 50 AR(H)



Diameter Ø4.3 | Round

G/H	Art. No.
0.5	GDAB 43 05 BAR(H)
1.0	GDAB 43 10 AR(H)
2.0	GDAB 43 20 AR(H)
3.0	GDAB 43 30 AR(H)
4.0	GDAB 43 40 AR(H)
5.0	GDAB 43 50 AR(H)

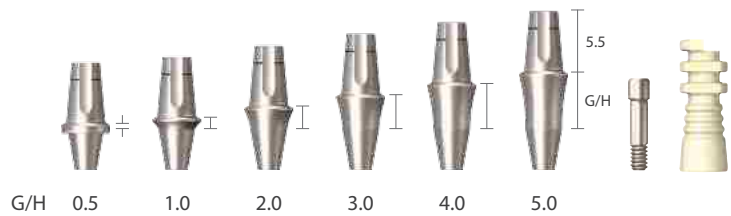

※ Note: It is recommended to keep the torque level at 20 N-cm to tighten the dual abutment with fixture

Dual Abutment [Round]

• Abutment screw is included

Unit: mm, Scale 1 : 1.5

Diameter Ø5.5 | Round

G/H	Art. No.
0.5	GDAB 55 05 BAR(H)
1.0	GDAB 55 10 AR(H)
2.0	GDAB 55 20 AR(H)
3.0	GDAB 55 30 AR(H)
4.0	GDAB 55 40 AR(H)
5.0	GDAB 55 50 AR(H)

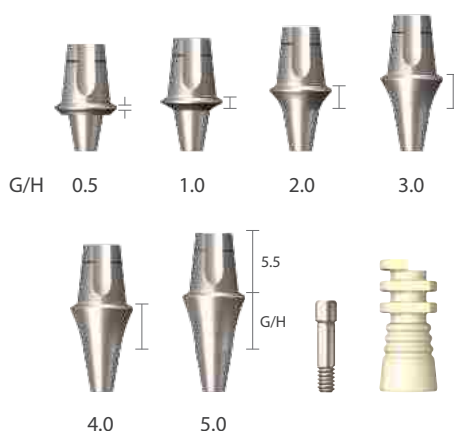

Diameter Ø6.5 | Round

G/H	Art. No.
0.5	GDAB 65 05 BAR(H)
1.0	GDAB 65 10 AR(H)
2.0	GDAB 65 20 AR(H)
3.0	GDAB 65 30 AR(H)
4.0	GDAB 65 40 AR(H)
5.0	GDAB 65 50 AR(H)

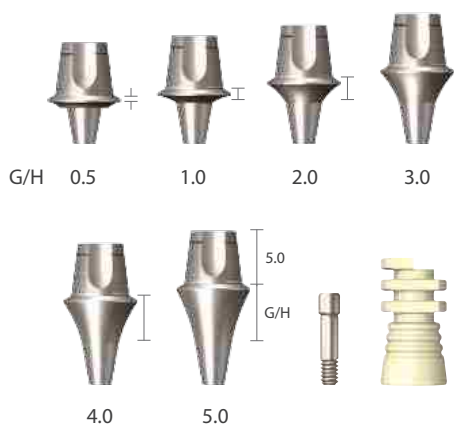

※ Note: It is recommended to keep the torque level at 20 N·cm to tighten the dual abutment with fixture

Abutment Level Impression Components

Unit: mm, Scale 1 : 1.5

Comfort Cap

Diameter	Art. No.
Ø3.7	GCC 37
Ø4.3	GCC 43
Ø5.5	GCC 55
Ø6.5	GCC 65

Ø 3.7



Ø 4.3



Ø 5.5



Ø 6.5



Impression Coping

Diameter	Art. No.
Ø3.7	GADH 37
Ø4.3	GADH 43
Ø5.5	GADH 55
Ø6.5	GADH 65

Ø 3.7



Ø 4.3



Ø 5.5



Ø 6.5



Analog

Diameter	Art. No.
Ø3.7	GCAN 37
Ø4.3	GCAN 43
Ø5.5	GCAN 55
Ø6.5	GCAN 65

Ø 3.7



Ø 4.3



Ø 5.5



Ø 6.5



Prosthetic Procedure 2

Impression Technique and Restoration Selection

Dual / Dual Milling / Angled / Metal-Casting / Temporary Abutment

Fixture Level Impression

Open Tray Technique
(Complication case)

Closed Tray Technique
(Simple case)

Impression Coping Pick-up

Square / Round
Ø3.7 / Ø4.3 / Ø5.5 / Ø6.5
Page 20, 21



Impression Coping Transfer

Square / Round
Ø3.7 / Ø4.3 / Ø5.5 / Ø6.5
Page 22, 23



Analog

Ø3.5 / Ø4.3
Page 21, 23



Dual Abutment

Square / Round
Ø3.7 / Ø4.3 / Ø5.5 / Ø6.5
Page 14, 15, 16, 17



Dual Milling Abutment

Square / Round
Ø3.7 / Ø4.3 / Ø5.5 / Ø6.5
Page 24, 25



Angled Abutment

Square / Round
15° / 25°
Ø3.7 / Ø4.3 / Ø5.5
Page 26, 27, 28, 29



Metal-Casting Abutment

Square / Round
Ø3.7 / Ø4.3
Page 30



Temporary Abutment

Square / Round
Ø3.7 / Ø4.3
Page 31

Modification

Cemented Restoration

Modification

Screw-Retained Restoration

Fixture Level Impression Coping

• Impression coping screw is included with Impression coping

Unit: mm, Scale 1 : 1.5

Impression Coping Pick-up Ø 3.7

Size	Type	Art. No.
Short	Square	GDPU 37 11 S
Short	Round	GDPU 37 11 R
Middle	Square	GDPU 37 13 S
Middle	Round	GDPU 37 13 R
Long	Square	GDPU 37 15 S
Long	Round	GDPU 37 15 R

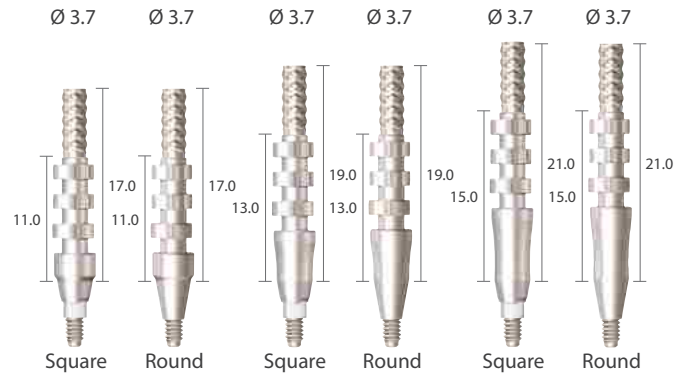

Impression Coping Pick-up Ø 4.3

Size	Type	Art. No.
Short	Square	GDPU 43 11 S
Short	Round	GDPU 43 11 R
Middle	Square	GDPU 43 13 S
Middle	Round	GDPU 43 13 R
Long	Square	GDPU 43 15 S
Long	Round	GDPU 43 15 R

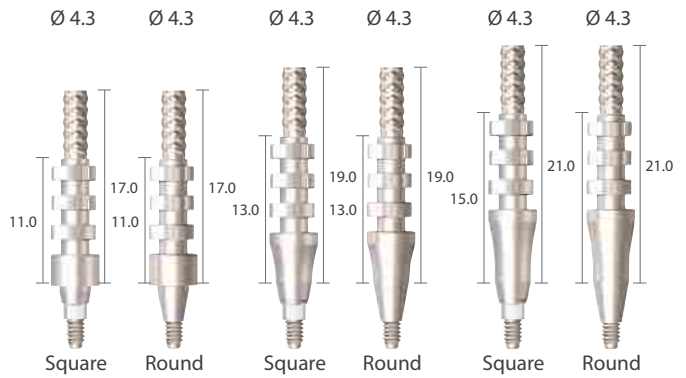

Impression Coping Pick-up Ø 5.5

Size	Type	Art. No.
Short	Square	GDPU 55 11 S
Short	Round	GDPU 55 11 R
Middle	Square	GDPU 55 13 S
Middle	Round	GDPU 55 13 R
Long	Square	GDPU 55 15 S
Long	Round	GDPU 55 15 R

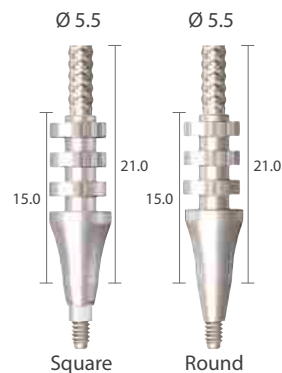
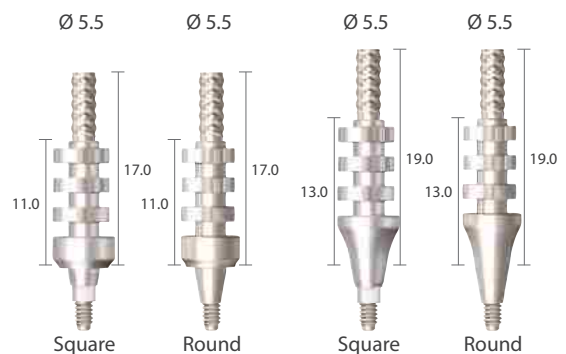

Fixture Level Impression Coping

• Impression coping screw is included with Impression coping

Unit: mm, Scale 1 : 1.5

Impression Coping Pick-up Ø 6.5

Size	Type	Art. No.
Short	Square	GDPU 65 11 S
Short	Round	GDPU 65 11 R
Middle	Square	GDPU 65 13 S
Middle	Round	GDPU 65 13 R
Long	Square	GDPU 65 15 S
Long	Round	GDPU 65 15 R

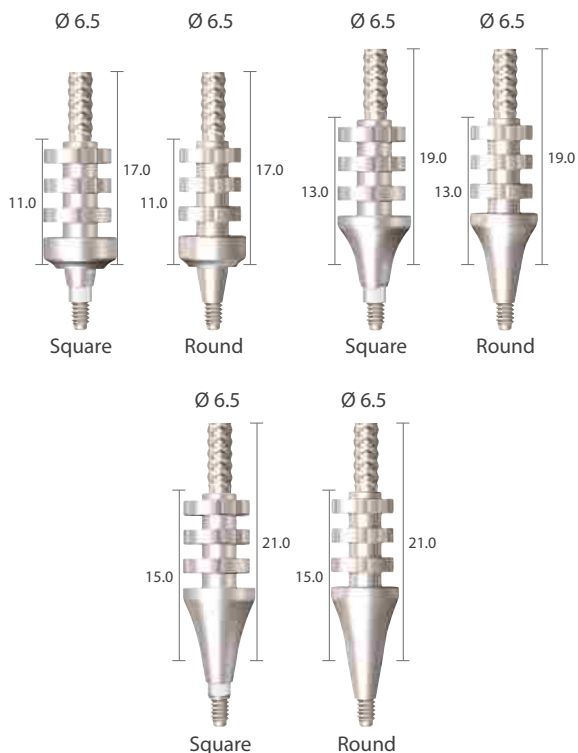

Impression Coping Pick-up Screw

Size	Art. No.
Short	GDPS 11
Middle	GDPS 13
Long	GDPS 15

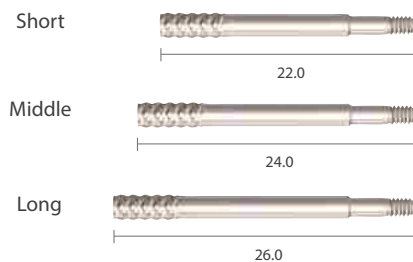

Analog

Application (Body Ø)	Art. No.
Ø3.1S	GDANR 30
Ø3.1 / Ø3.6S / Ø4.3S / Ø5.0S / Ø5.0W	GDANR 36

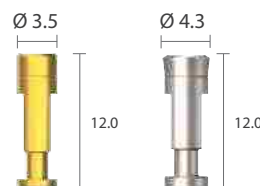

Fixture Level Impression Coping

• Impression coping screw is included with Impression coping

Unit: mm, Scale 1 : 1.5

Impression Coping Transfer Ø 3.7

Size	Type	Art. No.
Short	Square	GDTF 37 11 S
Short	Round	GDTF 37 11 R
Middle	Square	GDTF 37 13 S
Middle	Round	GDTF 37 13 R
Long	Square	GDTF 37 15 S
Long	Round	GDTF 37 15 R

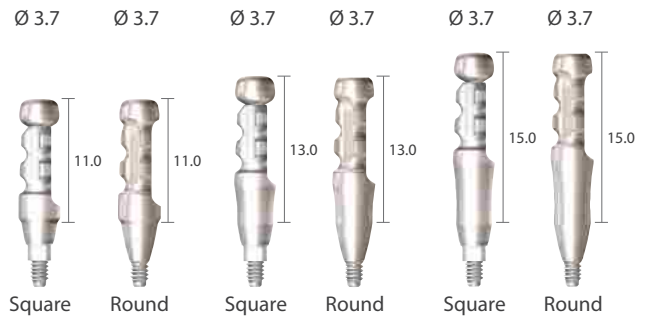

Impression Coping Transfer Ø 4.3

Size	Type	Art. No.
Short	Square	GDTF 43 11 S
Short	Round	GDTF 43 11 R
Middle	Square	GDTF 43 13 S
Middle	Round	GDTF 43 13 R
Long	Square	GDTF 43 15 S
Long	Round	GDTF 43 15 R

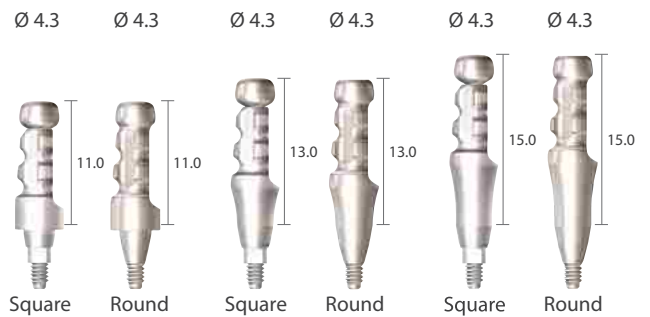

Impression Coping Transfer Ø 5.5

Size	Type	Art. No.
Short	Square	GDTF 55 11 S
Short	Round	GDTF 55 11 R
Middle	Square	GDTF 55 13 S
Middle	Round	GDTF 55 13 R
Long	Square	GDTF 55 15 S
Long	Round	GDTF 55 15 R

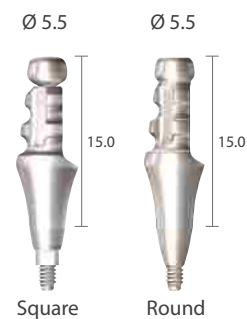
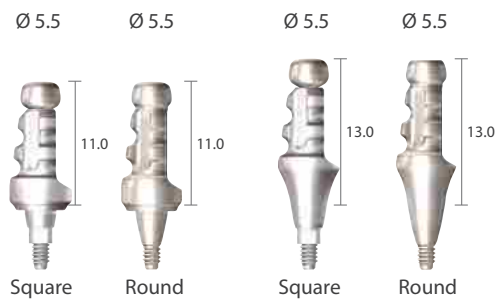

Fixture Level Impression Coping

• Impression coping screw is included with Impression coping

Unit: mm, Scale 1 : 1.5

Impression Coping Transfer Ø 6.5

Size	Type	Art. No.
Short	Square	GDTF 65 11 S
Short	Round	GDTF 65 11 R
Middle	Square	GDTF 65 13 S
Middle	Round	GDTF 65 13 R
Long	Square	GDTF 65 15 S
Long	Round	GDTF 65 15 R

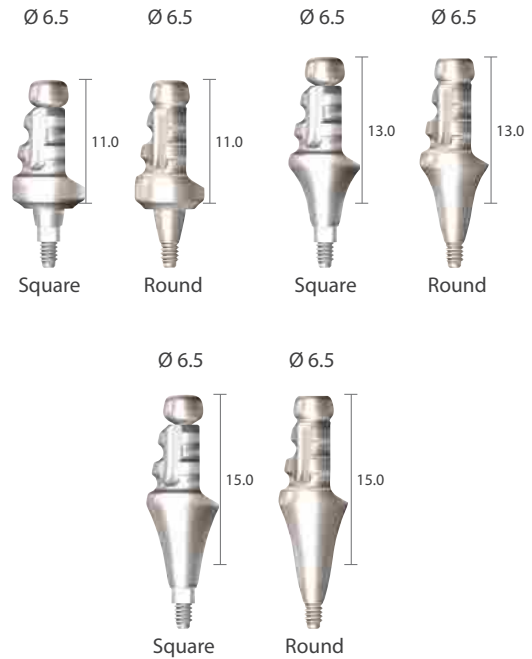

Impression Coping Transfer Screw

Size	Art. No.
Short	GDS 11
Middle	GDS 13
Long	GDS 15

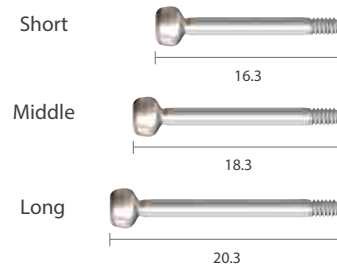

Analog

Application (Body Ø)	Art. No.
Ø3.1S	GDANR 30
Ø3.1 / Ø3.6S / Ø4.3S / Ø5.0S / Ø5.0W	GDANR 36

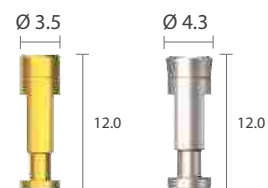

Dual Milling Abutment

• Abutment screw is included

Unit: mm, Scale 1 : 1.5



GMAB4320AS and GFX3609S

Diameter $\text{Ø } 3.7$

G/H	Type	Art. No.
1.0	Square	GMAB 37 10 AS
1.0	Round	GMAB 37 10 AR
2.0	Square	GMAB 37 20 AS
2.0	Round	GMAB 37 20 AR
3.0	Square	GMAB 37 30 AS
3.0	Round	GMAB 37 30 AR

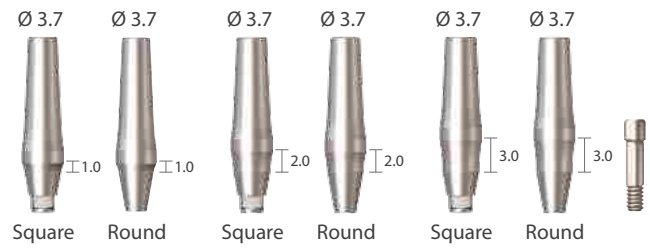

Diameter $\text{Ø } 4.3$

G/H	Type	Art. No.
1.0	Square	GMAB 43 10 AS
1.0	Round	GMAB 43 10 AR
2.0	Square	GMAB 43 20 AS
2.0	Round	GMAB 43 20 AR
3.0	Square	GMAB 43 30 AS
3.0	Round	GMAB 43 30 AR

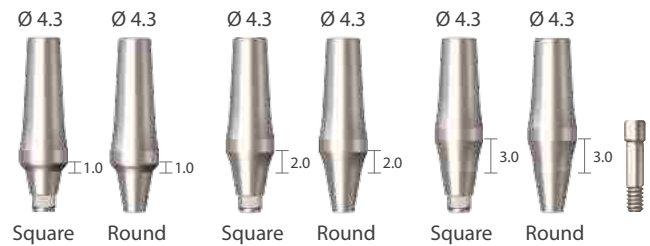

※ Note: It is recommended to keep the torque level at 20 N-cm to tighten the dual abutment with fixture

Dual Milling Abutment

• Abutment screw is included

Unit: mm, Scale 1 : 1.5

Diameter Ø 5.5

G/H	Type	Art. No.
1.0	Square	GMAB 55 10 AS
1.0	Round	GMAB 55 10 AR
2.0	Square	GMAB 55 20 AS
2.0	Round	GMAB 55 20 AR
3.0	Square	GMAB 55 30 AS
3.0	Round	GMAB 55 30 AR

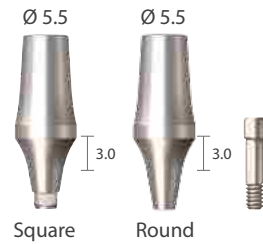

Diameter Ø6.5

G/H	Type	Art. No.
1.0	Square	GMAB 65 10 AS
1.0	Round	GMAB 65 10 AR
2.0	Square	GMAB 65 20 AS
2.0	Round	GMAB 65 20 AR
3.0	Square	GMAB 65 30 AS
3.0	Round	GMAB 65 30 AR

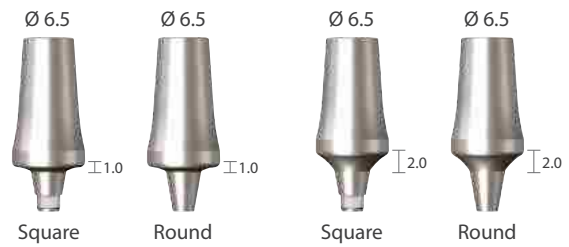

※ Note: It is recommended to keep the torque level at 20 N·cm to tighten the dual abutment with fixture

Angled Abutment [15°]

• Abutment screw is included

Unit: mm, Scale 1 : 1.5

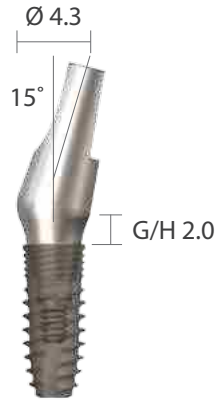

GAAB154320AS and GFX3609S

Diameter Ø 3.7 | Angled 15°

G/H	Type	Art. No.
1.0	Square	GAAB 15 37 10 AS
1.0	Round	GAAB 15 37 10 AR
2.0	Square	GAAB 15 37 20 AS
2.0	Round	GAAB 15 37 20 AR
3.0	Square	GAAB 15 37 30 AS
3.0	Round	GAAB 15 37 30 AR



※ Note: It is recommended to keep the torque level at 20 N-cm to tighten the dual abutment with fixture

Angled Abutment [15°]

• Abutment screw is included

Unit: mm, Scale 1 : 1.5

Diameter Ø 4.3 | Angled 15°

G/H	Type	Art. No.
1.0	Square	GAAB 15 43 10 AS
1.0	Round	GAAB 15 43 10 AR
2.0	Square	GAAB 15 43 20 AS
2.0	Round	GAAB 15 43 20 AR
3.0	Square	GAAB 15 43 30 AS
3.0	Round	GAAB 15 43 30 AR

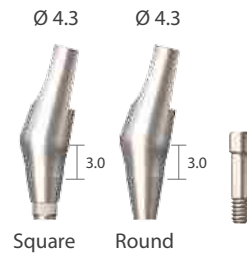
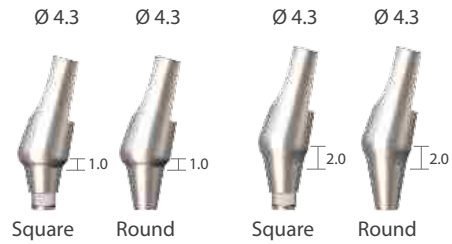

Diameter Ø 5.5 | Angled 15°

G/H	Type	Art. No.
1.0	Square	GAAB 15 55 10 AS
1.0	Round	GAAB 15 55 10 AR
2.0	Square	GAAB 15 55 20 AS
2.0	Round	GAAB 15 55 20 AR
3.0	Square	GAAB 15 55 30 AS
3.0	Round	GAAB 15 55 30 AR



※ Note: It is recommended to keep the torque level at 20 N·cm to tighten the dual abutment with fixture

Angled Abutment [25°]

• Abutment screw is included

Unit: mm, Scale 1 : 1.5



GAAB254320AS and GFX3609S

Diameter Ø 3.7 | Angled 25°

G/H	Type	Art. No.
1.0	Square	GAAB 25 37 10 AS
1.0	Round	GAAB 25 37 10 AR
2.0	Square	GAAB 25 37 20 AS
2.0	Round	GAAB 25 37 20 AR
3.0	Square	GAAB 25 37 30 AS
3.0	Round	GAAB 25 37 30 AR



※ Note: It is recommended to keep the torque level at 20 N-cm to tighten the dual abutment with fixture

Angled Abutment [25°]

• Abutment screw is included

Unit: mm, Scale 1 : 1.5

Diameter Ø 4.3 | Angled 25°

G/H	Type	Art. No.
1.0	Square	GAAB 25 43 10 AS
1.0	Round	GAAB 25 43 10 AR
2.0	Square	GAAB 25 43 20 AS
2.0	Round	GAAB 25 43 20 AR
3.0	Square	GAAB 25 43 30 AS
3.0	Round	GAAB 25 43 30 AR

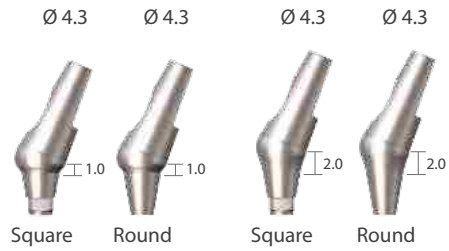

Diameter Ø 5.5 | Angled 25°

G/H	Type	Art. No.
1.0	Square	GAAB 25 55 10 AS
1.0	Round	GAAB 25 55 10 AR
2.0	Square	GAAB 25 55 20 AS
2.0	Round	GAAB 25 55 20 AR
3.0	Square	GAAB 25 55 30 AS
3.0	Round	GAAB 25 55 30 AR



※ Note: It is recommended to keep the torque level at 20 N·cm to tighten the dual abutment with fixture

Metal Casting Abutment

• Abutment screw is included

Unit: mm, Scale 1 : 1.5



GRAB43CS and GFX3609S

Metal-Casting Abutment

G/H	Type	Art. No.
1.0	Square	GRAB 37 CS
1.0	Round	GRAB 37 CR
1.0	Square	GRAB 43 CS
1.0	Round	GRAB 43 CR

Ø 3.7



Square

Ø 3.7



Round

Ø 4.3



Square

Ø 4.3



Round



※ Note: It is recommended to keep the torque level at 20 N-cm to tighten the dual abutment with fixture

Temporary Abutment

• Abutment screw is included.

Unit: mm, Scale 1 : 1.5



GRAB43TS and GFX3609S

Ti-Temporary Abutment

G/H	Type	Art. No.
1.0	Square	GRAB 37 TS
1.0	Round	GRAB 37 TR
1.0	Square	GRAB 43 TS
1.0	Round	GRAB 43 TR

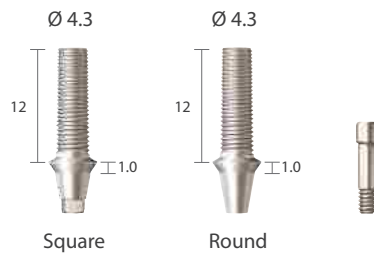
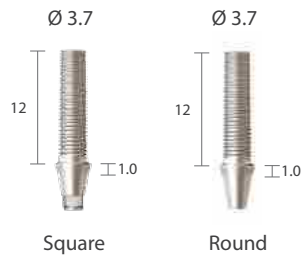

※ Note: It is recommended to keep the torque level at 20 N·cm to tighten the dual abutment with fixture

Prosthetic Procedure 3

Impression Technique and Restoration Selection

Screw Abutment

Abutment Level Impression

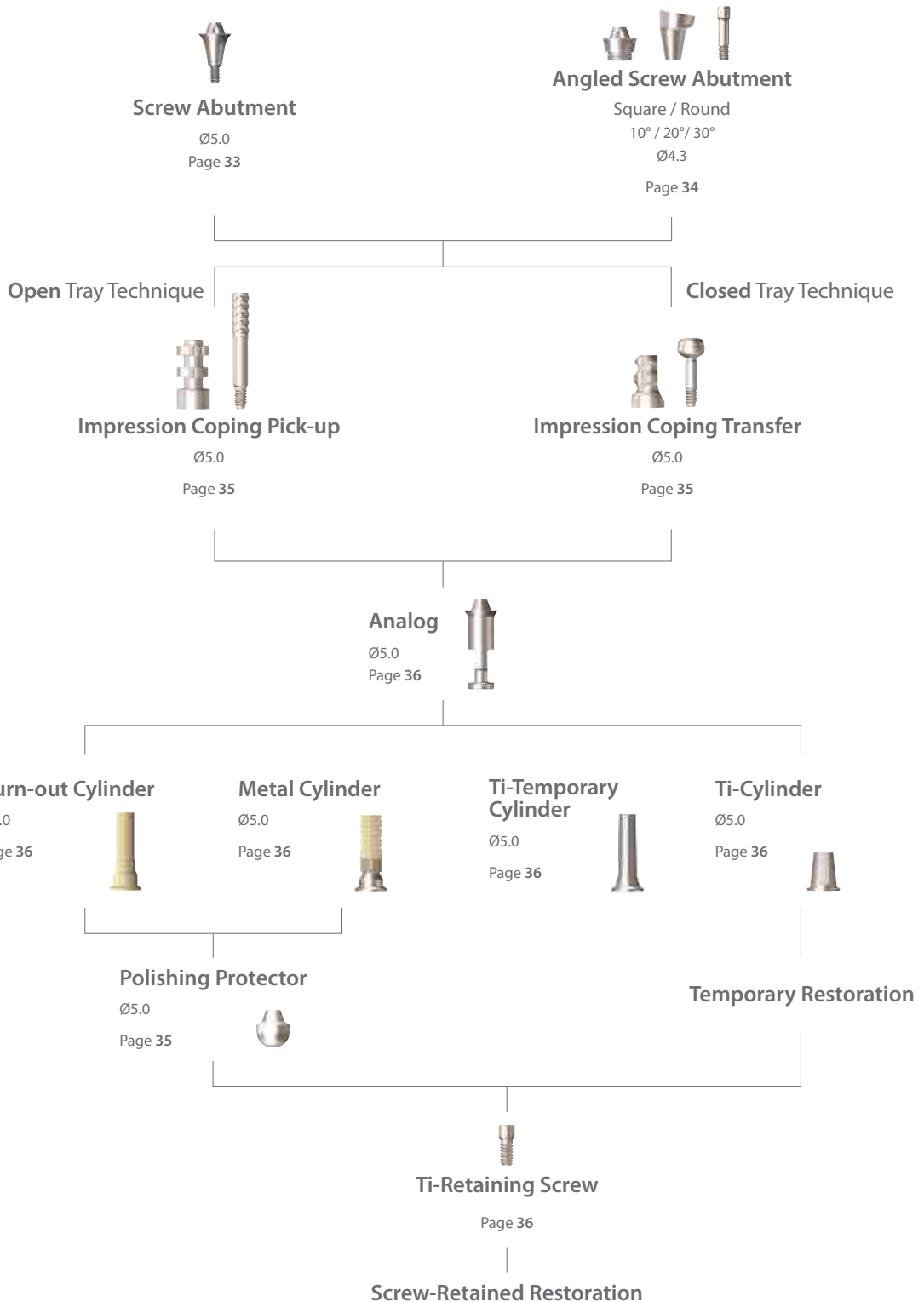

Screw Abutment

Unit: mm, Scale 1 : 1.5



Delivery Holder



GSAB5020A and GFX3609S

Diameter Ø 5.0

G/H	Art. No.
0.5	GSAB 50 05 BA
1.0	GSAB 50 10 A
2.0	GSAB 50 20 A
3.0	GSAB 50 30 A
4.0	GSAB 50 40 A
5.0	GSAB 50 50 A

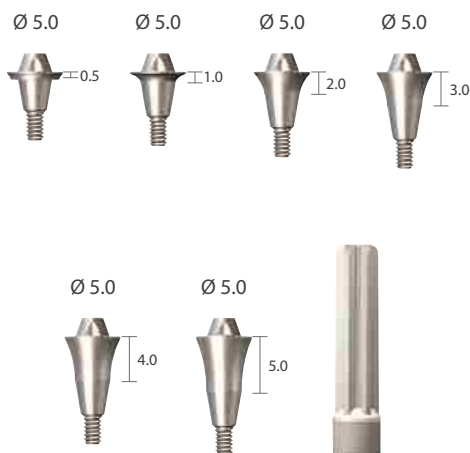

※ Note: It is recommended to keep the torque level at 20 N·cm to tighten the dual abutment with fixture

Angled Screw Abutment

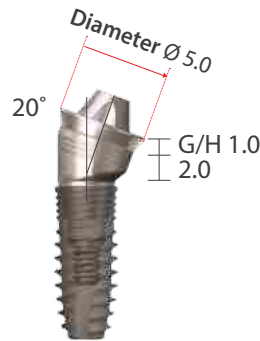

Unit: mm, Scale 1 : 1.5

GAOS5010A and GAOB432020AS and GFX3609S

Base Abutment

Diameter	Angle	Art. No.
Ø4.3	10°	GAOB 43 20 10 AS
Ø4.3	10°	GAOB 43 20 10 AR
Ø4.3	20°	GAOB 43 20 20 AS
Ø4.3	20°	GAOB 43 20 20 AR
Ø4.3	30°	GAOB 43 20 30 AS
Ø4.3	30°	GAOB 43 20 30 AR

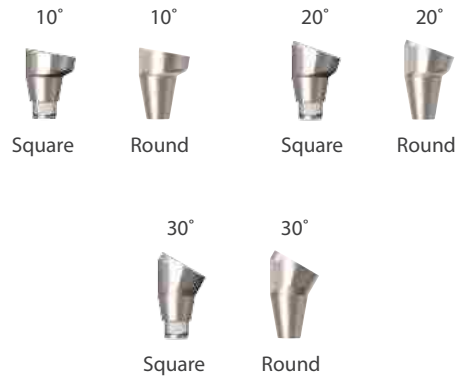

Screw Cap

G/H	Art. No.
1.0	GAOS 50 10 A
2.0	GAOS 50 20 A
3.0	GAOS 50 30 A



Healing Abutment

G/H	Art. No.
1.0	GAOC 50 10 A
2.0	GAOC 50 20 A
3.0	GAOC 50 30 A



Screw

GAOSC1619



※ Note: It is recommended to keep the torque level at 20 N-cm to tighten the dual abutment with fixture

Screw Abutment Impression Components

Unit: mm, Scale 1 : 1.5

Impression Coping Pick-up | Bridge

Diameter	Art. No.
Ø5.0	GSPU 50

Ø 5.0



Impression Coping Transfer | Bridge

Diameter	Art. No.
Ø5.0	GSTF 50

Ø 5.0



Impression Coping Screw

Type	Art. No.
Pick-up	GSPS 09
Transfer	GSTS 09

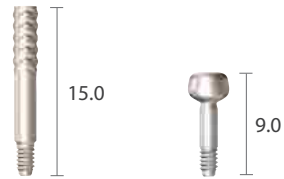

Comfort Cap

Diameter	Art. No.
Ø5.0	GSCC 50

Ø 5.0



Polishing Protector

Diameter	Art. No.
Ø5.0	GSPP 50

Ø 5.0



Screw Abutment Impression Components

Unit: mm, Scale 1 : 1.5

Analog

Diameter	Art. No.
Ø5.0	GSAN 50

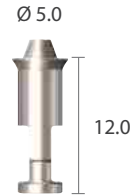

Ti-Cylinder

Diameter	Art. No.
Ø5.0	GSTA 50 A



Ti-Temporary Cylinder

Diameter	Art. No.
Ø5.0	GSTC 50 AT

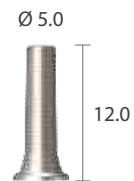

Burn-out Cylinder

Diameter	Art. No.
Ø5.0	GSBC 50



Metal Cylinder

Diameter	Art. No.
Ø5.0	GSGC 50 C

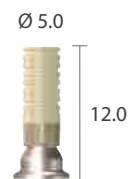

Ti-Retaining Screw

GSRs 16 T	
-----------	--



Prosthetic Procedure 4

Impression Technique and Restoration Selection

Overdenture Procedure Mini Ball / Magnetic Attachment

Abutment Level Impression



Mini Ball Impression Coping

Page 38

Mini Ball Analog

Page 38

Socket Spacer

Page 38

Mini Denture Socket

Page 38

Mini O-ring

Page 38

Magnetic Assay

Page 40

Mini Ball and Socket Attachment for Overdenture

Magnetic Attachment for Overdenture

Mini Ball Attachment

Unit: mm, Scale 1 : 1.5



BPF3 and GBAB3520 and GFX3609S

Mini Ball Abutment

G/H	Art. No.
1.0	GBAB 35 10
2.0	GBAB 35 20
3.0	GBAB 35 30
4.0	GBAB 35 40
5.0	GBAB 35 50

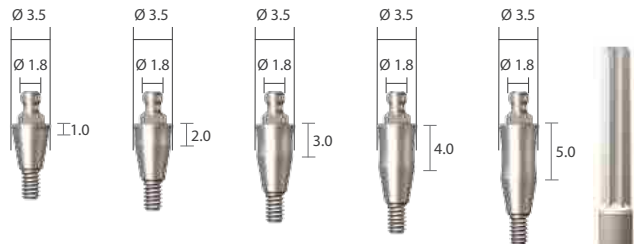

Mini Ball Impression Coping

GICA



Mini Ball Analog

BANL



Socket Spacer

Art. No.	GBIC3L GBIC2L
----------	------------------



Female Socket

Art. No.	BPF3 (300~500gf) BPF2 (500~700gf)
----------	--------------------------------------

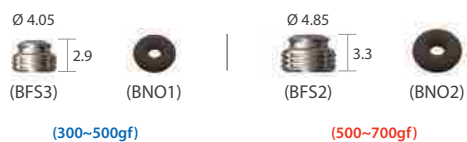

※ Note: It is recommended to keep the torque level at 20 N-cm to tighten the dual abutment with fixture

Angled Mini Ball Attachment

Unit: mm, Scale 1 : 1.5



GAOB4310A and GAOB432010AS and GFX3609S

Base Abutment

Diameter	Angle	Art. No.
Ø4.3	10°	GAOB 43 20 10 AS
Ø4.3	10°	GAOB 43 20 10 AR
Ø4.3	20°	GAOB 43 20 20 AS
Ø4.3	20°	GAOB 43 20 20 AR
Ø4.3	30°	GAOB 43 20 30 AS
Ø4.3	30°	GAOB 43 20 30 AR

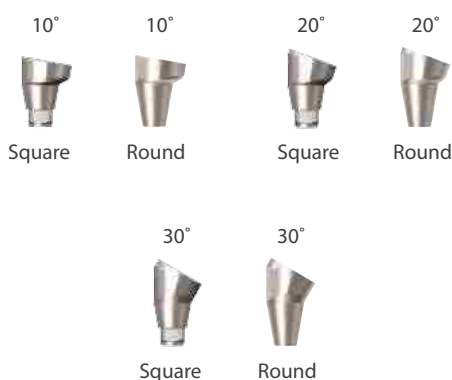

Mini Ball Cap

G/H	Art. No.
1.0	GAOB 43 10 A
2.0	GAOB 43 20 A
3.0	GAOB 43 30 A



Angled Overdenture Screw

GAOSC1619

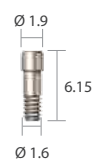

※ Note: It is recommended to keep the torque level at 20 N-cm to tighten the dual abutment with fixture

Magnetic Attachment

Unit: mm, Scale 1 : 1.5

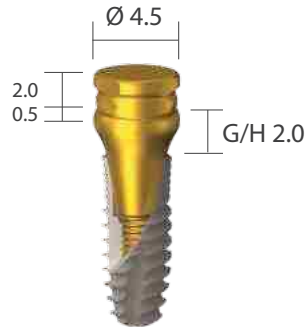

MGT4520D and GMK4520D and GFX3609S

Magnetic Assay

Application	Diameter	H	Art. No.
MKP45D	Ø4.5	2.0	MGT 45 20 D
MKP55D	Ø4.5	2.0	MGT 55 20 D

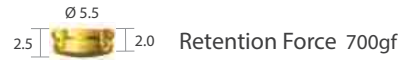
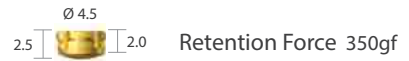

Implant Keeper Diameter Ø 4.5

G/H	Art. No.
1.0	GMK 45 10 D
2.0	GMK 45 20 D
3.0	GMK 45 30 D
4.0	GMK 45 40 D
5.0	GMK 45 50 D

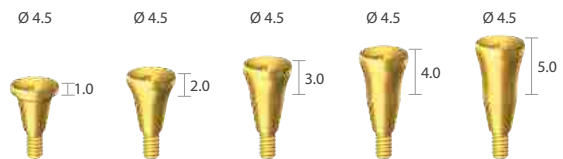

Implant Keeper Diameter Ø 5.5

G/H	Art. No.
1.0	GMK 55 10 D
2.0	GMK 55 20 D
3.0	GMK 55 30 D
4.0	GMK 55 40 D
5.0	GMK 55 50 D

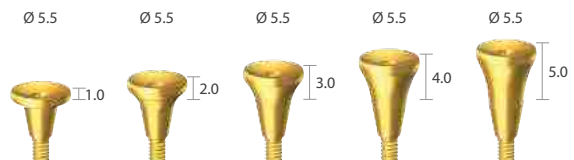

※ Note: It is recommended to keep the torque level at 20 N-cm to tighten the dual abutment with fixture

Surgical Kit

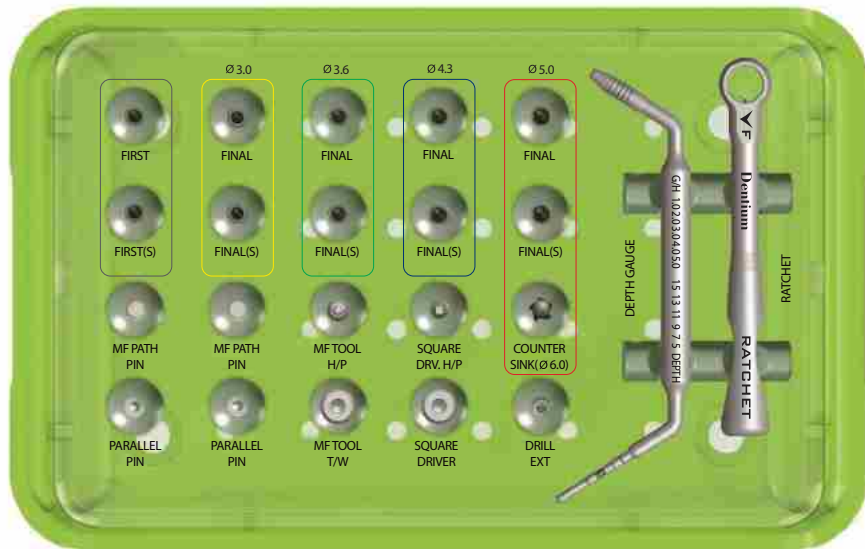

NRLine Surgical Kit

GXIFK

Kit includes



Stopper Kit

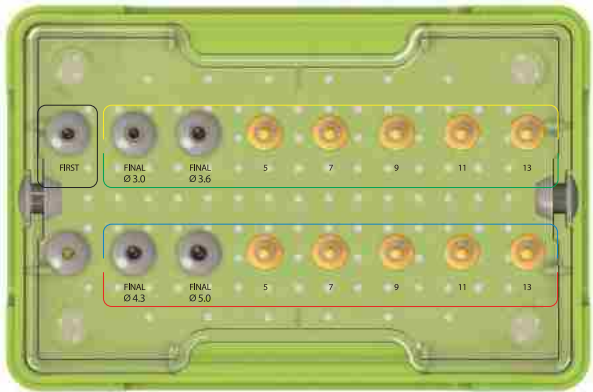

NRLine Stopper Kit

GXDS

Kit includes



Prosthetic Kit

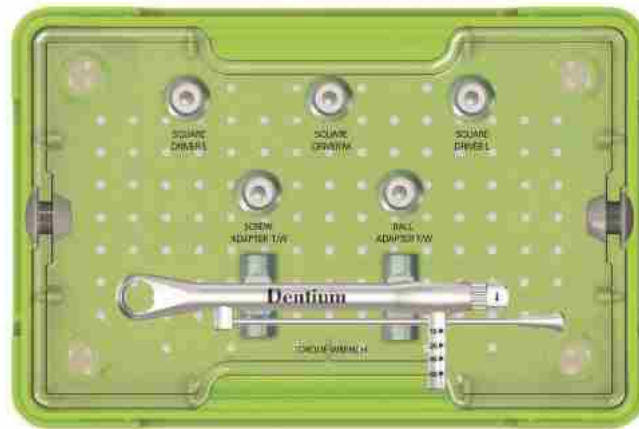

NRLine Prosthetic Kit

GXNP

Kit includes



GXSD 15 W



GXSD 21 W



GXSD 28 W



GXSA 21W



GXBA 21W



GXNTW

Drill

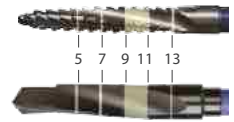

Unit: mm, Scale 1 : 1

First Guide Drill

Diameter	L	Art. No.
Ø2.6	29	GXLD 22 29
Ø2.6	31	GXLD 22 31
Ø2.6	35	GXLD 22 35

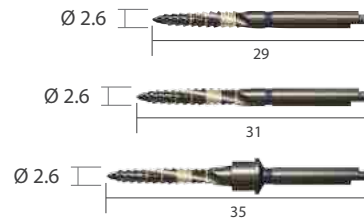

Final Drill

Diameter	L	Art. No.
Ø2.95	29	GXFD 30 29
Ø3.35	29	GXFD 36 29
Ø3.95	29	GXFD 43 29
Ø4.75	29	GXFD 50 29

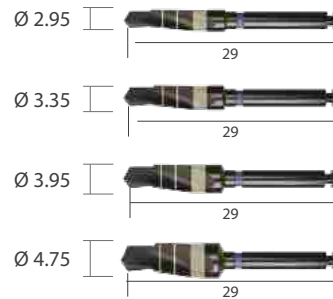

Final Drill

Diameter	L	Art. No.
Ø2.95	31	GXFD 30 31
Ø3.35	31	GXFD 36 31
Ø3.95	31	GXFD 43 31
Ø4.75	31	GXFD 50 31

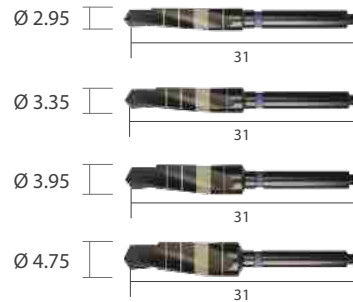

Final Drill

Diameter	L	Art. No.
Ø2.95	35	GXFD 30 35
Ø3.35	35	GXFD 36 35
Ø3.95	35	GXFD 43 35
Ø4.75	35	GXFD 50 35



※ Note: Drill speed 1,000rpm, 30~45N-cm with irrigation

Drill

Unit: mm, Scale 1 : 1

Final Drill | Option

Diameter	L	Art. No.
Ø2.95	35	GXFH 30 35
Ø3.35	35	GXFH 36 35
Ø3.95	35	GXFH 43 35
Ø4.75	35	GXFH 50 35

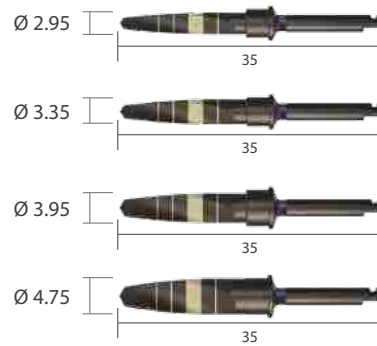

Countersink

Diameter	L	Art. No.
Ø6.0	29	GXCS 50 29 W



※ Note: Drill speed 1,000rpm, 30~45N·cm with irrigation

Instrument

Unit: mm, Scale 1 : 1

Stopper | For final drill 3035, 3635

Drilling Depth	L	Art. No.
13	5.6	GXDST 13
11	7.6	GXDST 11
9	9.6	GXDST 09
7	11.6	GXDST 07
5	13.6	GXDST 05

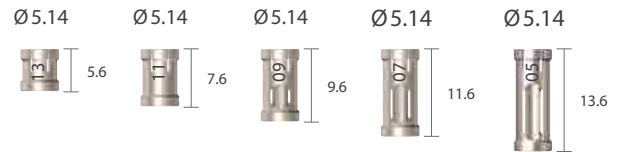

Stopper | For final drill 4335, 5035

Drilling Depth	L	Art. No.
13	5.6	GXDST 13 L
11	7.6	GXDST 11 L
9	9.6	GXDST 09 L
7	11.6	GXDST 07 L
5	13.6	GXDST 05 L

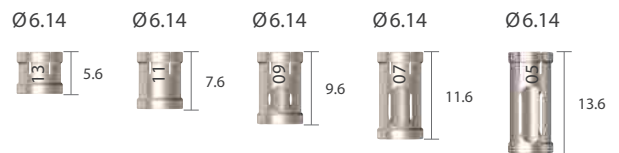

Adapter

Type	L	Art. No.
Hand-piece	27	GXID 27 H
	30	GXID 30 H
	32	GXID 32 H
Ratchet	24	GXID 24 W
	26	GXID 26 W
	29	GXID 29 W

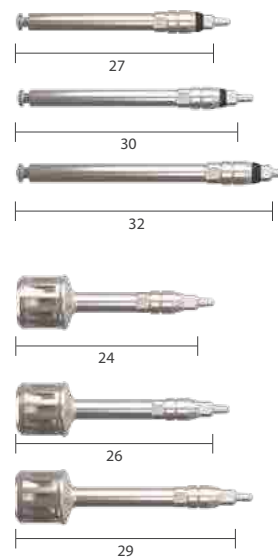

※ Note: Drill speed 1,000rpm, 30~45N-cm with irrigation

Instrument

Unit: mm, Scale 1 : 1

Parallel Pin

Diameter	L	Art. No.
Ø4.3	23.6	GXPP 162243

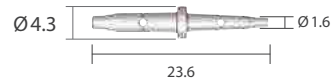

Path Pin

L	Art. No.
17.3	GXMFP A



Square Driver

Type	L	Art. No.
Hand-piece	25	GXSD 25 H
Ratchet	15	GXSD 15 W
	21	GXSD 21 W
	25	GXSD 25 W
	28	GXSD 28 W

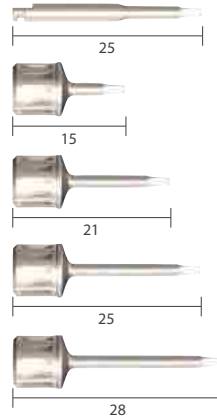

Angled Square Driver

Type	L	Art. No.
Hand-piece	25	GXAD 25 H
Ratchet	15	GXAD 15 W
	21	GXAD 21 W
	25	GXAD 25 W
	28	GXAD 28 W

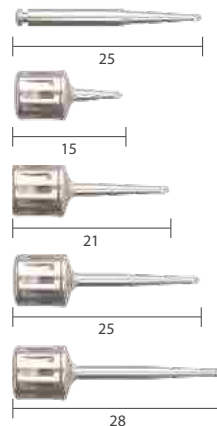

Drill Extension

XDE

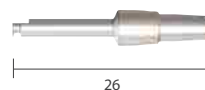

※ Note: Drill speed 1,000rpm, 30~45N·cm with irrigation

Instrument

Unit: mm, Scale 1 : 1

Adapter for Screw Abutment

GXSA21W



Adapter for Ball Abutment

GXBA21W



Ratchet

GXRCA



Torque Wrench | Scale 1 : 0.7

GXNTW



Depth Gauge

GXDGL

※ Note: One side of Depth Gauge measures the osteotomy depth and the other side measures the gingival height from the top of the implant



Prosthetic and Laboratory Instrument

Unit: mm, Scale 1 : 1

Reamer Guide for Dual Abutment

Art. No.
GDRG 37
GDRG 43
GDRG 55
GDRG 65



Reamer Guide for Screw Abutment

GSRG



Reamer

GSRM



Reamer Handle

CRH





SURGICAL MANUAL

Surgical Drill Sequence	52
Drilling Depth Guide	54
Fixture Connection	56
Installation Procedure & Warnings	57
Surgical Kit Maintenance	58

Surgical Drill Sequence

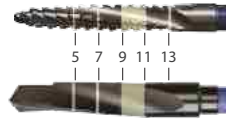

Drilling Sequence Guide

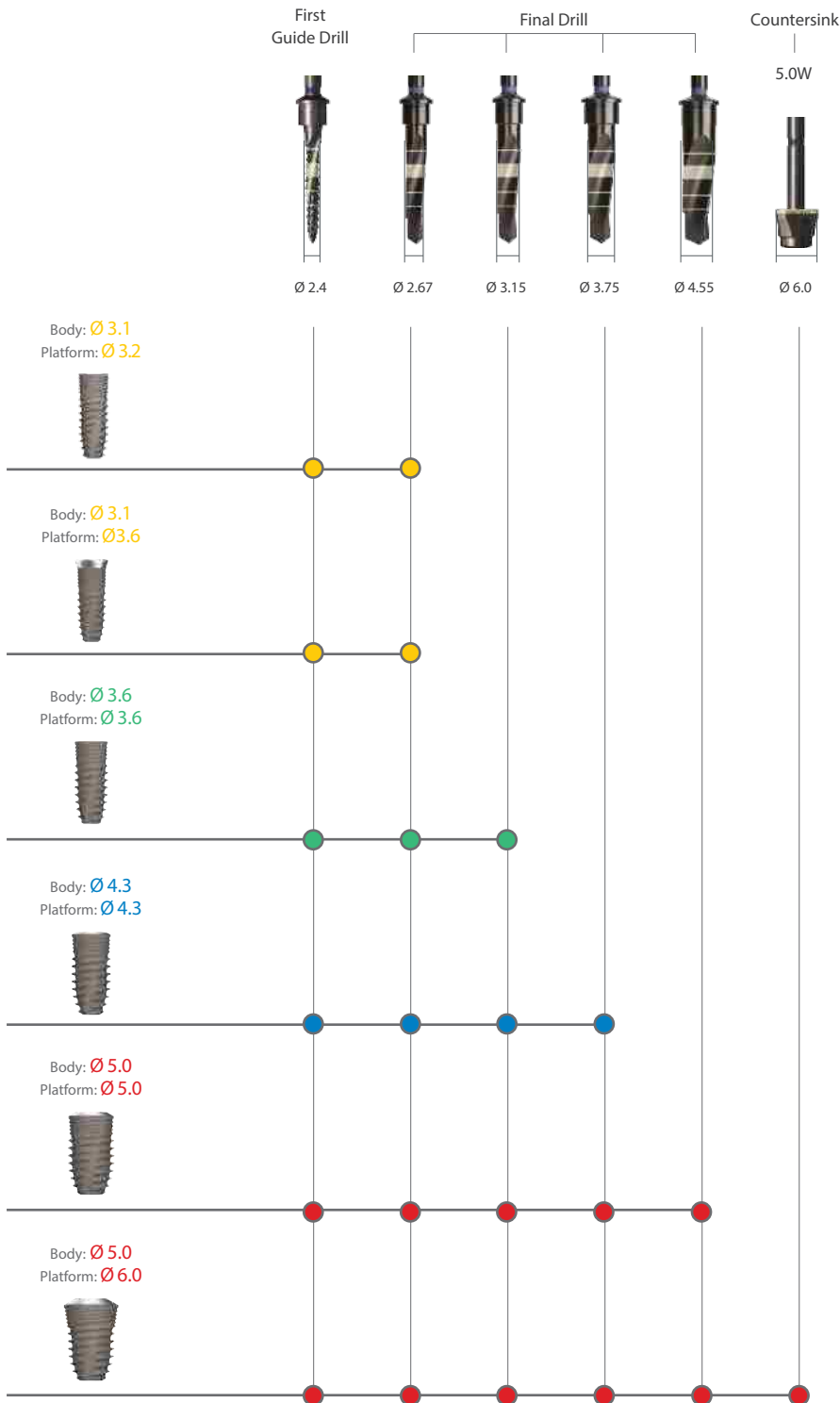

Determination of Fixture Top Level

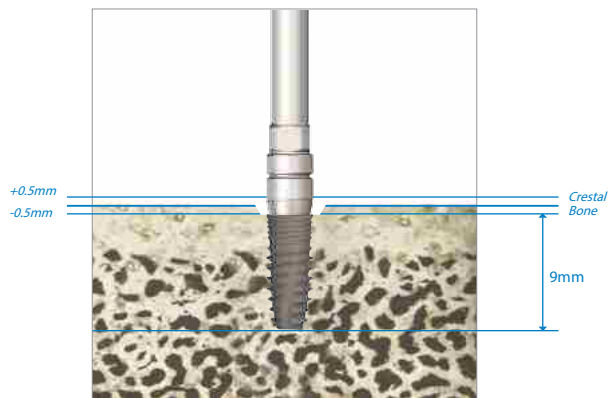

Top level of fixture needs to be located 0.5mm below the marginal crestal bone level to minimize bone loss after implantation.

Depth Indication

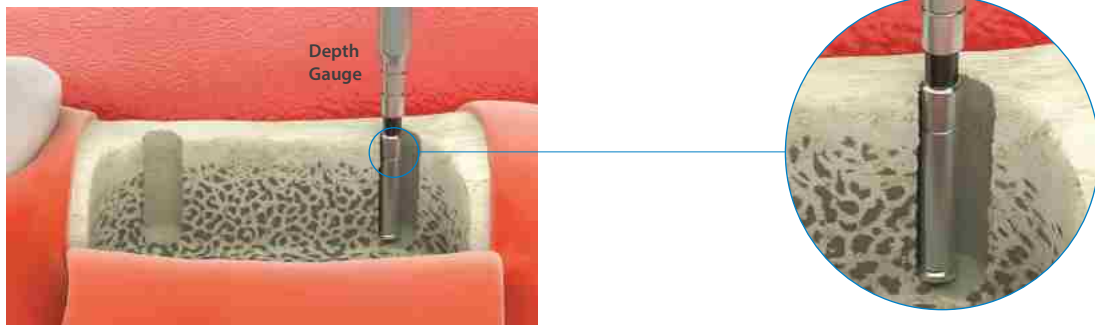

- Use the depth gauge after first guide drill to check depth of drilling.
- Place the depth gauge against the wall of the osteotomy.

Drilling Depth Guide (Bone Level)

Body: Ø 3.1 / Platform: Ø 3.2

(800~1,200rpm / 30~45N-cm)

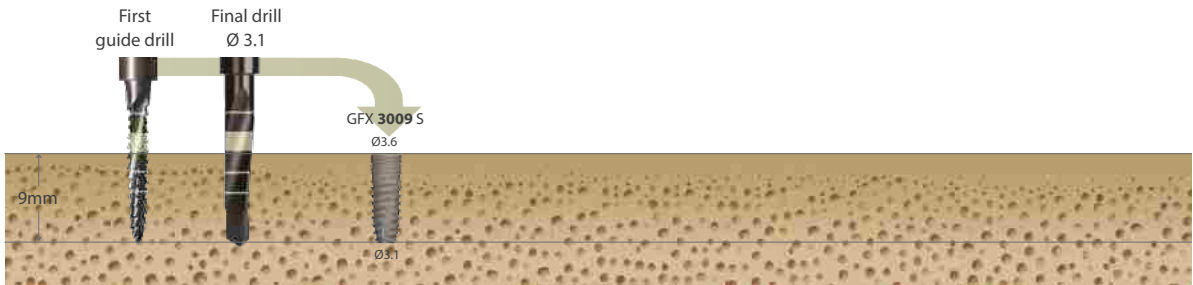

Body: Ø 3.1 / Platform: Ø 3.6

(800~1,200rpm / 30~45N-cm)



Body: Ø 3.6 / Platform: Ø 3.6

(800~1,200rpm / 30~45N-cm)

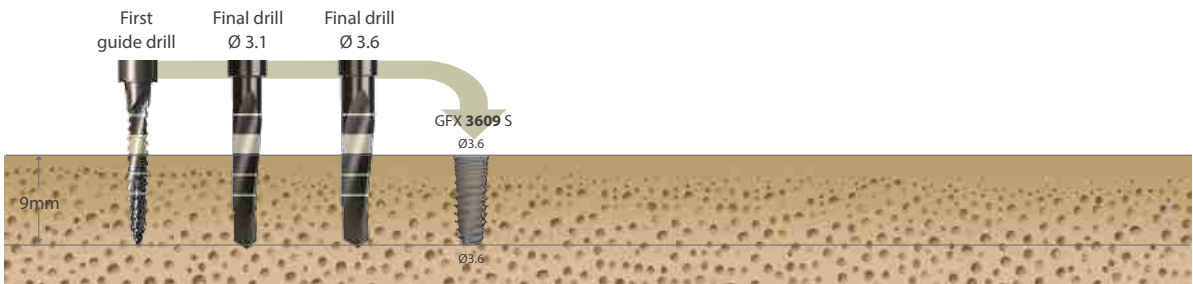

Drilling Depth Guide (Bone Level)

Body: Ø 4.3 / Platform: Ø 4.3

(800~1,200rpm / 30~45N-cm)

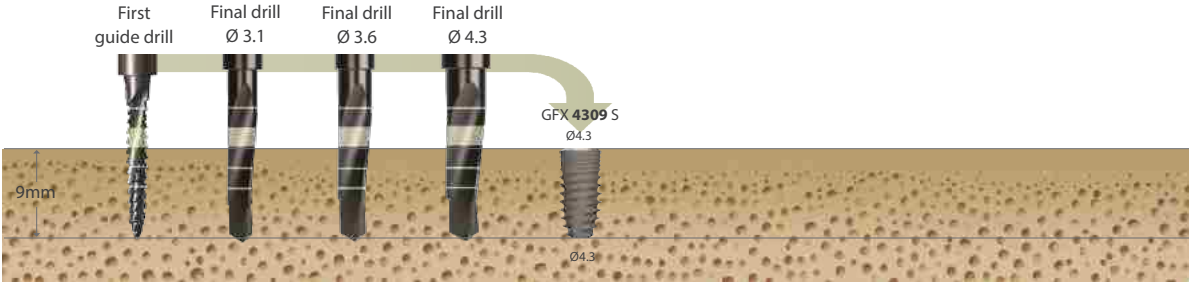

Body: Ø 5.0 / Platform: Ø 5.0

(800~1,200rpm / 30~45N-cm)

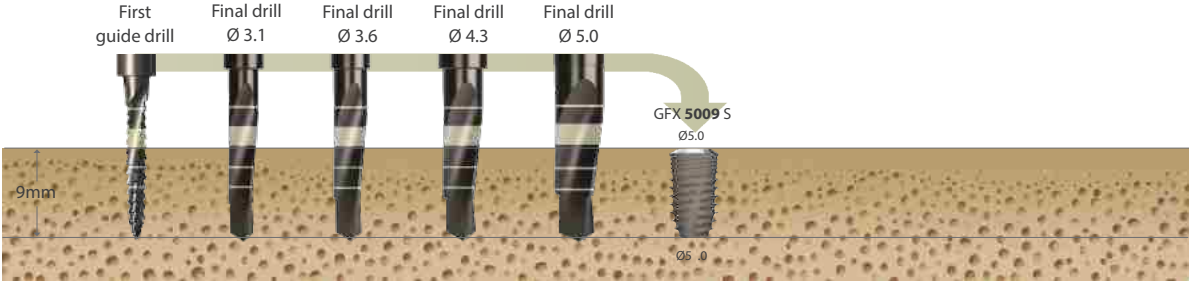

Body: Ø 5.0 / Platform: Ø 6.0

(800~1,200rpm / 30~45N-cm)

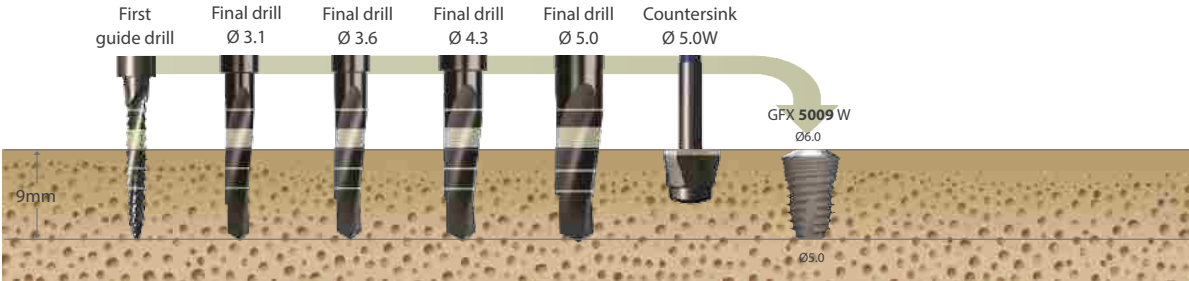

Fixture Connection



Caution

When opening the fixture pack, hold the fixture container upward and engage the adapter into the fixture.



By hand-piece
20rpm / 35N-cm



By ratchet



Directions Using the Hand-piece / Ratchet Adapter

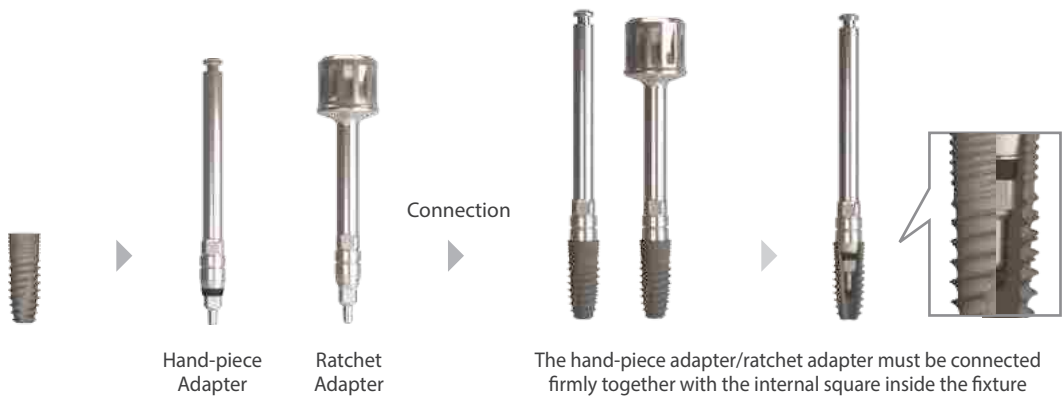

Installation Procedure & Warnings

Sterilization and Instrument Care Procedures

Cover Screw



By square driver



Cover screw (GCS36)
connection

Healing Abutment



By square driver



Healing Abutment connection



Healing Abutment (GHAB371525)
connection in thin gingiva

Warnings

Dental Implant surgery and restoration involve complex dental procedures. Appropriate and adequate training in proper technique is strongly recommended prior to use.

- Improper medical examination and/or treatment plan can result in implant failure and/or loss of supportive bone.
- Improper initial stability and/or excessive occlusal forces during healing period may lead to osseointegration failure.
- Excessive insertion torque may lead to mechanical failure or implant biologic failure due to bone compression and necrosis.
- When forces or loads are greater than its design, implant or abutment fracture could happen. Therefore clinicians should make careful decisions with regards to clinical treatment planning to minimize the risk of fracture. Appropriate implant quantity, occlusal interface and a nightguard are essential. Potential excessive loading conditions may include the following:

- 01 Inadequate number of implants are placed.
- 02 Implant width and/or length are inappropriate for a treatment site.
- 03 Prosthesis which has excessive cantilever length due to inadequate biomechanical design
- 04 Continuous occlusal force are generated by incomplete connection between implant and abutment and/or abutment screw loosening.
- 05 Metal Casting Abutment angles are greater than 30° from the vertical axis of the implant.
- 06 Occlusal interferences causing excessive lateral forces
- 07 Patient parafunctions such as bruxism
- 08 Inadequate dental laboratory casting procedures
- 09 Improper prosthesis fit
- 10 Trauma from patient habits or accidents
- 11 Excessive marginal bone loss caused by inadequate bone width and/or advanced peri-implantitis.

Surgical Kit Maintenance

Manual Cleaning and Sterilization Procedure

It is important to use protective clothing and face shield while cleaning contaminated instruments. Always wear protective glasses, mask, gloves, etc. for your safety.

Cleaning

- 1 Rinse instruments immediately after use under running tap water (<40°C) for a minimum of one (1) minute to remove all debris including extraneous body fluids, bone debris and tissue.
- 2 Soak all instruments immediately after rinsing in an enzymatic cleaning solution* for 10 to 20 minutes (Do not soak overnight).
 - * Follow manufacturer's instructions and observe recommended cleaning solution concentrations (enzymatic detergent with a pH level between 7-10 and temperature not to exceed 40°C). Do not use incompatible cleaning solutions to clean instruments.
- 3 For internal irrigation drills, use a 1mL syringe and a 25 gauge needle to clean the drill irrigation hole with a minimum of 0.2 mL of the prepared cleaning solution. Repeat this step two (2) more times for a total of three (3) rinses.
- 4 Scrub with a soft brush for a minimum of 1 (one) minute to remove any debris inside the drill irrigation hole.
- 5 Rinse the instruments under running tap water (<40°C) for a minimum of 1 minute. Use a 1mL syringe and a 25 gauge needle with a minimum of 0.2 mL of tap water to forcefully flush inside the drill irrigation hole. Repeat flushing of drill irrigation hole two (2) more times for a total of three (3) flushings.
- 6 Place instruments into an ultrasonic cleaner with neutral detergent**. Keep instruments inside the ultrasonic bath for 15 minutes using a frequency of 25-50 kHz. Ensure multiple instruments placed within the bath remain separated.
 - ** Follow manufacturer's instructions and observe recommended neutral detergent solution concentrations (neutral detergent with a pH level between 7-10 and temperature not to exceed 40°C). Do not use incompatible neutral detergent solutions to clean instruments.
- 7 Rinse instruments thoroughly with running tap water (<40°C) for a minimum of 1 (one) minute until all traces of neutral detergent solution are removed. Rinse inside drill irrigation hole using a 1mL syringe and a 25 gauge needle with a minimum of 0.2 mL of tap water. Repeat rinsing drill irrigation hole two (2) more times for a total of three (3) rinses.
- 8 Gently wipe instruments with a soft lint-free cloth or place the instruments in a drying cabinet (60°C for less than 10 hours) until fully dry. Blow residual water from drill irrigation hole using a 1mL syringe and a 25 gauge needle. Visually inspect instruments in a well-lit area to ensure they are clean, dry and free of residue.
- 9 Clean instrument trays with a germicidal cleaner prior to returning instruments into Kit.
- 10 Always check for damage or corrosion after rinsing and drying.

Sterilization

Dentium recommends either the Pre-vacuum or Gravity autoclave methods for sterilization under the conditions described below. However, autoclave performance can affect the efficacy of this process. Healthcare facilities should validate their sterilization processes employing the actual equipment and operators that routinely sterilize instruments.

All autoclaves/sterilizers should be regularly validated, maintained and checked in accordance with EN 285/EN 13060, EN ISO 17665, ANSI AAMI ST79 to ensure compliance with these and related standards. Make sure packaging is suitable for steam sterilization.

Recommended Sterilization Parameters

Method-Moist Heat Sterilization	Pre-vacuum	Gravity
Set Point Temperature	132 °C	132 °C
Exposure time	4 minutes	30 minutes
Drying time	20 minutes	40 minutes

PROSTHESIS MANUAL

Prosthetic Introduction

Understanding the Implant and Prosthesis	60
Types of Abutment	61
Dual Abutment	62
Dual Milling / Angled / Temporary / Metal-Casting Abutment	63
Screw Abutment	65
Points to Consider in Abutment Selection	66

Prosthetic Procedure 1

Abutment Level- Dual Abutment	68
-------------------------------	----

Prosthetic Procedure 2

Fixture Level [Pick-up Type]- Dual Abutment	72
Fixture Level [Transfer Type]- Dual Abutment	75
Fixture Level [Transfer Type]- Dual Milling Abutment	78
Fixture Level [Pick-up Type]- Angled Abutment	80
Fixture Level- Metal-Casting Abutment	82
Fixture Level [Pick-up Type]- Temporary Abutment	83

Prosthetic Procedure 3

Abutment Level [Transfer Type]- Screw Abutment	85
--	----

Cementation Repair Method (SCRIP)

88

Prosthetic Procedure 4

Mini Ball Attachment	91
Angled Mini Ball Attachment	93
Magnetic Attachment	95

Understanding the Implant and Prosthesis

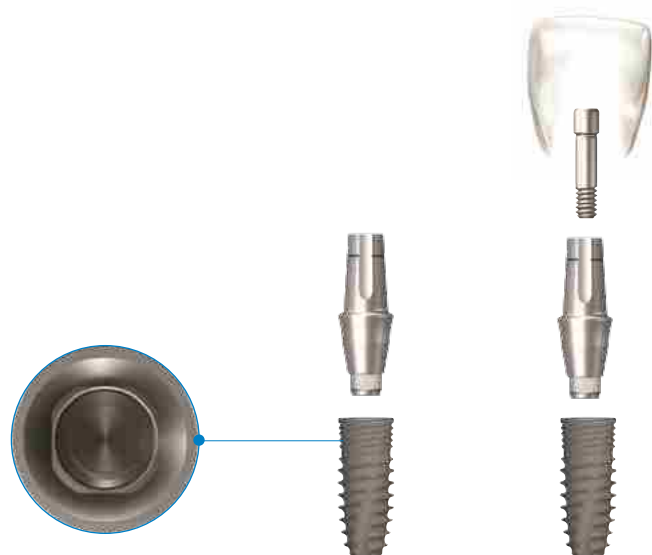

Firm & Stable Connection

- The tapered conical square connection between implant and abutment interface provides hermetic sealing.
- The biological connection distributes the load to the fixture evenly. Therefore it may minimize bone loss.
- All implant diameters share the same internal connection. One abutment screw fits all abutments and fixtures.

Types of Abutment (Abutments are available in various diameters & gingival heights)

- | | | |
|---|---|---------------------------------|
| • Dual Abutment | — | Abutment level |
| • Dual Abutment | } | Fixture level |
| • Dual Milling Abutment | | |
| • Angled Abutment (15°/25°) | | |
| • Metal-Casting Abutment | | |
| • Temporary Abutment | | |
| • Screw Abutment | } | Screw retained (Abutment level) |
| • Angled Screw Abutment (10°/ 20°/ 30°) | | |
| • Mini Ball Attachment | } | For denture use |
| • Angled Mini Ball Attachment (10°/ 20°/ 30°) | | |
| • Magnetic Attachment | | |

Types of Abutment

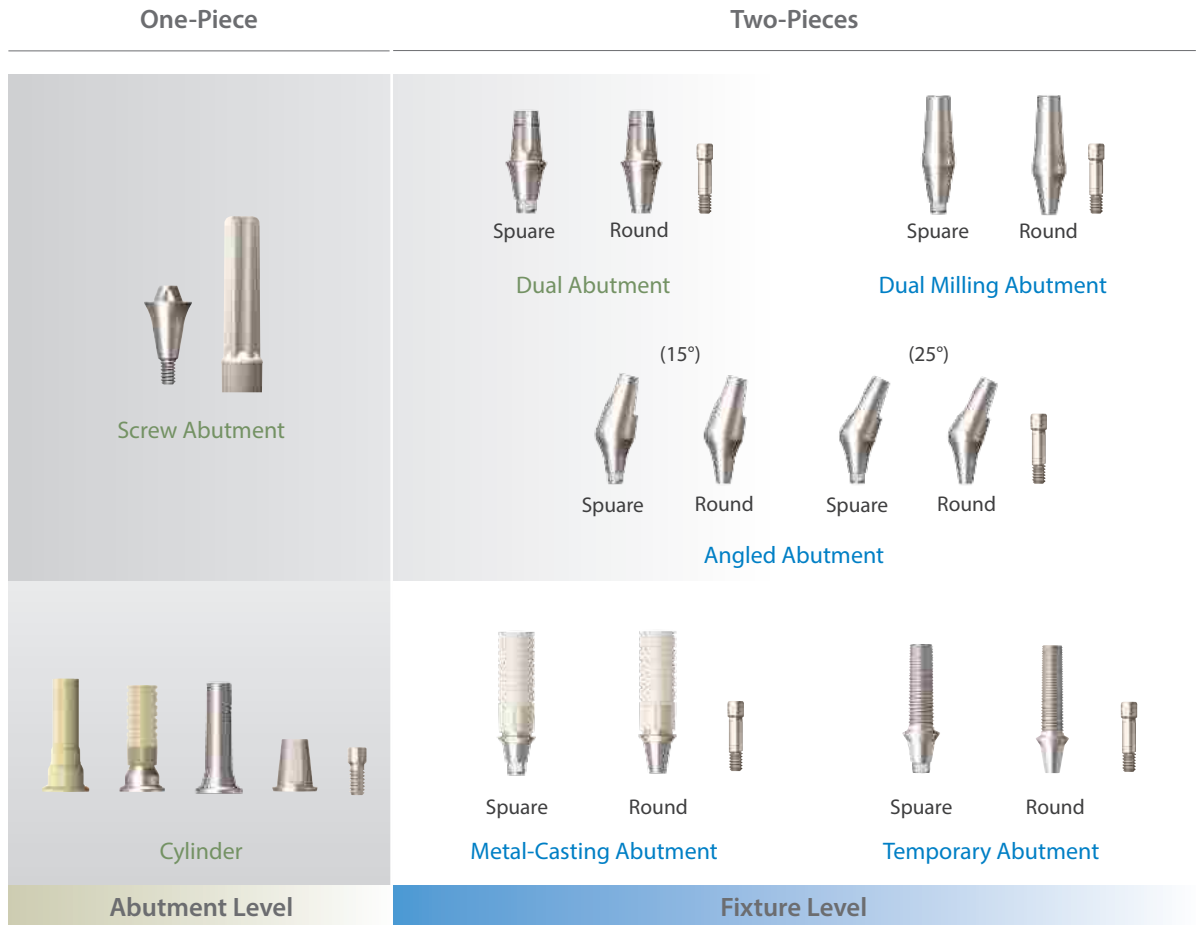

- Straight abutments are Dual and Milling Abutment.
- Depending on the insertion angle and position of the fixture, the Angled or Metal-Casting / Temporary Abutment may be used.
- The Screw Abutment can be used when prosthesis retrieval is anticipated.

Selection Guideline

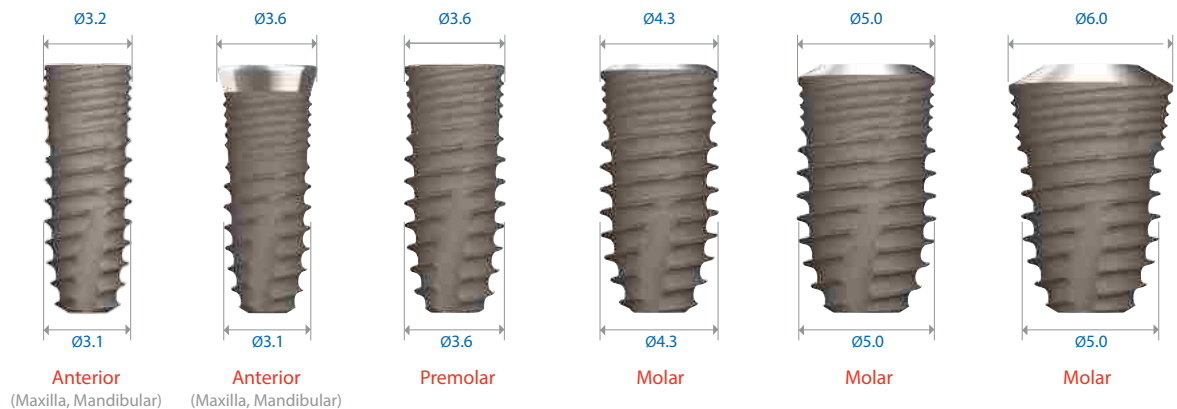

Dual Abutment

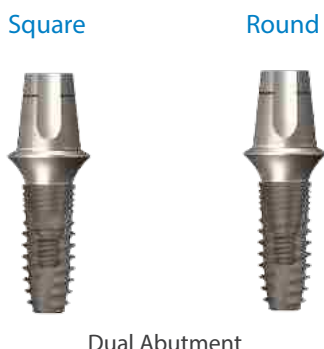

- It is possible to take an impression at both fixture level and abutment level.
- If the abutment selection is made in the mouth, gauge the thickness of gingiva with depth gauge to decide the appropriate abutment gingival height.
- For abutment level impressions, the impression is taken with the snap cap.
- When using the Dual Abutment with abutment level impression, it remains in the mouth after the impression is taken.
- For fixture level impressions, the abutment selection takes place on the master model.
- For fixture level impressions, a precise positioning jig for abutment may be required.
- Either square or round abutments may be used, according to operators preference.

* If a cement retained restoration requires retrieval, cutting a hole in the occlusal surface would allow access to the screw to permit removal.

Square / Round

	Square	Round
Positioning Jig	Unnecessary	Required
Radiograph	Required	Unnecessary

Dual Abutment (Square / Round)

Diameter	G/H	Vertical Angle
Ø3.7	0.5mm, 1.0mm, 2.0mm, 3.0mm, 4.0mm, 5.0mm	3.5°
Ø4.3	0.5mm, 1.0mm, 2.0mm, 3.0mm, 4.0mm, 5.0mm	5°
Ø5.5	0.5mm, 1.0mm, 2.0mm, 3.0mm, 4.0mm, 5.0mm	6°
Ø6.5	0.5mm, 1.0mm, 2.0mm, 3.0mm, 4.0mm, 5.0mm	7°



Dual Milling / Angled / Temporary / Metal-Casting Abutment

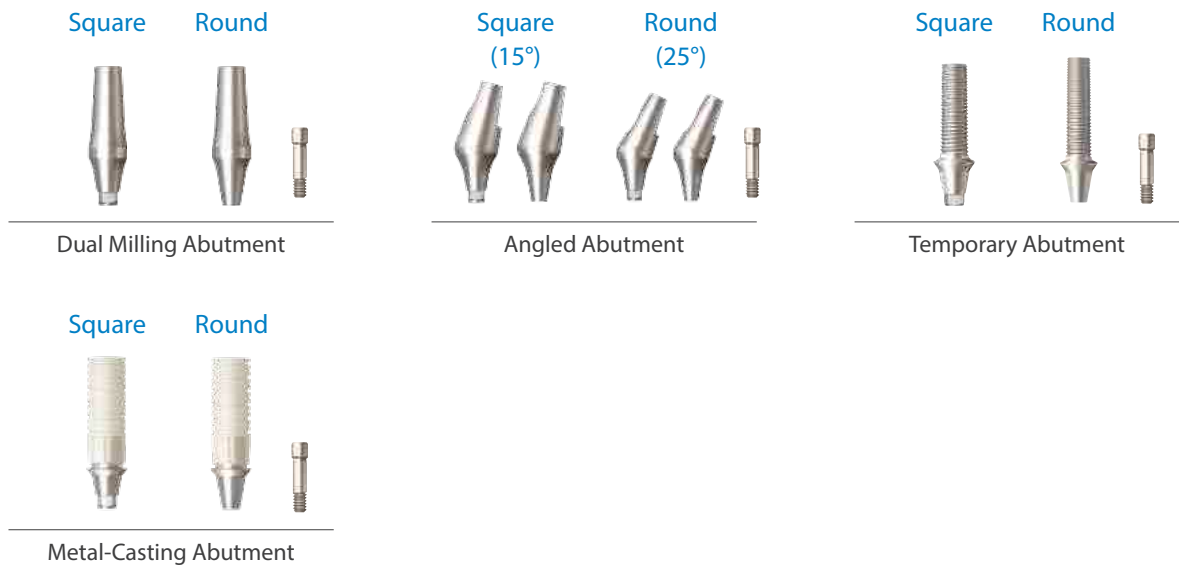

Angled Abutment

- The Angled Abutment is recommended when the restoration path of insertion is unfavorable in either anterior or posterior sites.
- Retention force can be increased through milling process.

Metal-Casting Abutment

- Equivalent results for a fraction of the price.
- Our highly affordable metal alloy replaces expensive gold to alleviate financial burden to all.



Temporary Abutment

- Temporary Abutments are available with titanium.
- The titanium abutment comes in square and round both with a gingival height of 1.0mm.

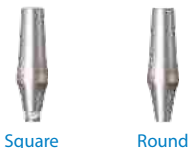

Dual Milling / Angled / Temporary / Metal-Casting Abutment

Fixture Level Abutment (Square / Round)

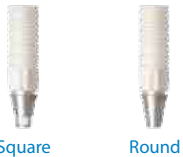
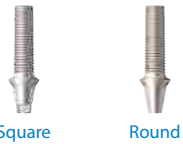
Abutment	Diameter	G/H	Angle
Dual Milling Abutment 	Ø3.7	1.0mm 2.0mm 3.0mm	X
	Ø4.3	1.0mm 2.0mm 3.0mm	
	Ø5.5	1.0mm 2.0mm 3.0mm	
	Ø6.5	1.0mm 2.0mm 3.0mm	
Angled Abutment 	Ø3.7	1.0mm 2.0mm 3.0mm	15° / 25°
	Ø4.3	1.0mm 2.0mm 3.0mm	15° / 25°
	Ø5.5	1.0mm 2.0mm 3.0mm	15° / 25°
Metal-Casting Abutment 	Ø3.7	1.0mm	X
	Ø4.3	1.0mm	
Temporary Abutment 	Ø3.7	1.0mm	X
	Ø4.3	1.0mm	

Screw Abutment



Screw Abutment

If prosthesis repair is anticipated, use of a Screw Abutment retained prosthesis enables easy retrieval.

- Useful for connecting multiple units or when there is a preference for a screw retained prosthesis.
- Useful when respective long axes of implants differ. Each side tapers by 30° and this permits up to 60° divergence between two abutments.
- Useful when the prognosis of an adjacent restoration is not ideal thus permitting easy retrieval and modification of the restoration.

Ti-Retaining Screw (1.6mm - body diameter)

- Can minimize screw loosening due to increased approximal space.
- Can endure various kinds of masticatory force.

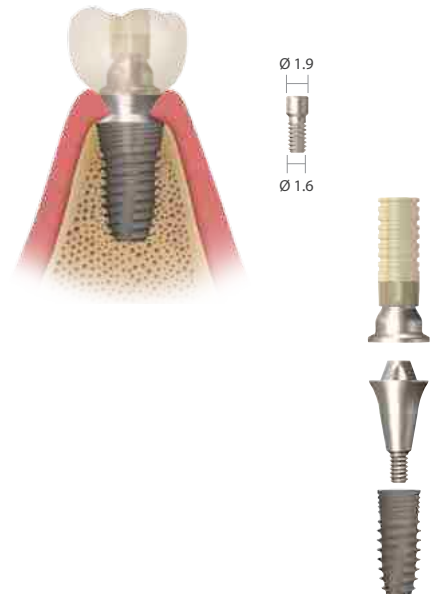

Screw Abutment

Diameter	G/H
Ø5.0	0.5mm, 1.0mm, 2.0mm, 3.0mm, 4.0mm, 5.0mm

Angled Screw Abutment

Diameter	G/H	Angle
Ø4.3	1.0mm, 2.0mm, 3.0mm	10° / 20° / 30°

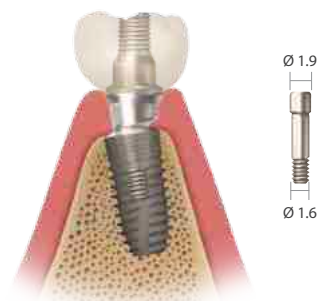

Points to Consider in Abutment Selection

Considerations in Selecting an Abutment

- Esthetic requirement
- Implant angulation
- Implant location
- Fixture installation depth (Gingival height)
- Interarch distance
- Prosthesis type
- Dentist & dental technician's preference

Impression of Implant

According to the case the impression can be taken at abutment or fixture level.

Fixture Level

- 1 Dual Abutment
- 2 Dual Milling Abutment
- 3 Angled Abutment (15° / 25°)
- 4 Metal-Casting Abutment
- 5 Temporary Abutment (Titanium)

Abutment Level

- 1 Dual Abutment
- 2 Screw Abutment
- 3 Angled Screw Abutment (10° / 20° / 30°)

Abutment Impression Recommendation

Dual Abutment	Cementation type, screw-cementation type	Fixture level impression or abutment level impression
Dual Milling Abutment	Cementation type, screw-cementation type	Fixture level impression
Angled Abutment	Cementation type, screw-cementation type	Fixture level impression
Screw Abutment	Screw retained type	Abutment level impression
Metal-Casting Abutment	Cementation type, screw-cementation type	Fixture level impression
Temporary Abutment	Cementation type, screw-cementation type	Fixture level impression

Prosthetic Procedure 1

Impression Technique and Restoration Selection

Dual Abutment

Abutment Level Impression

Closed Tray Technique



Dual Abutment

Square / Round
Ø3.7 / Ø4.3 / Ø5.5 / Ø6.5



Impression Coping

(Burn-Out Cylinder, Comfort Cap, Abutment Holder)
Ø3.7 / Ø4.3 / Ø5.5 / Ø6.5



Comfort Cap

Ø3.7 / Ø4.3 / Ø5.5 / Ø6.5



Analog

Ø3.7 / Ø4.3 / Ø5.5 / Ø6.5

Modification

Cemented Restoration

Abutment Level- Dual Abutment

[Multiple Units]

Clinical Procedure

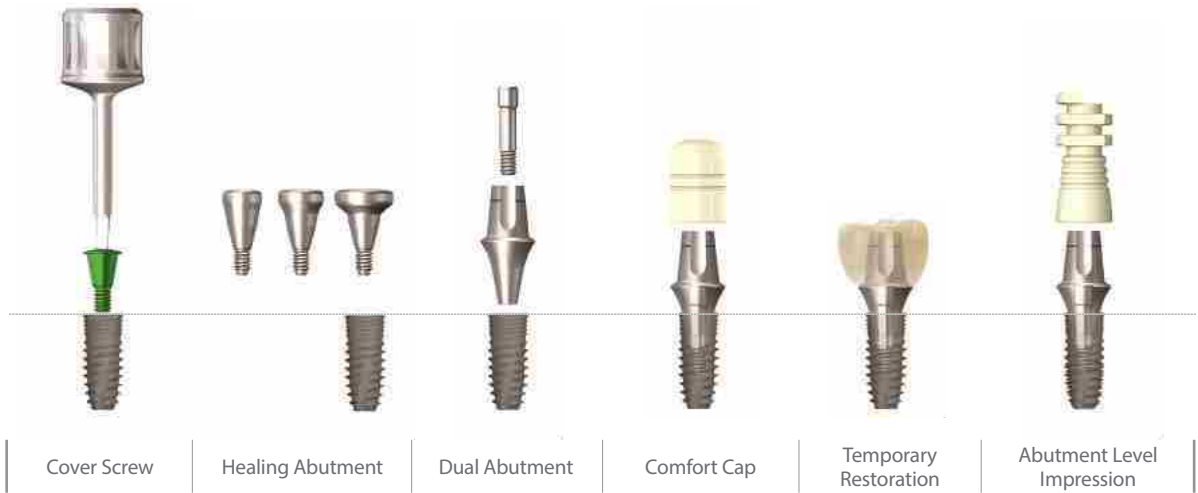

Chairside



Remove the Healing Abutment after formation of soft tissue.



Dual Abutment (Square / Round)



Select the Dual Abutment by diameter and gingival height.



Retighten after 15 minutes tighten it to 20N-cm.



Seat the plastic cap over the abutment.



Injection of impression material



Impression taking



Cap comes off into the impression.



Fabrication of provisional restoration or insertion of comfort cap

Abutment Level- Dual Abutment

[Multiple Units]

Laboratory Procedure

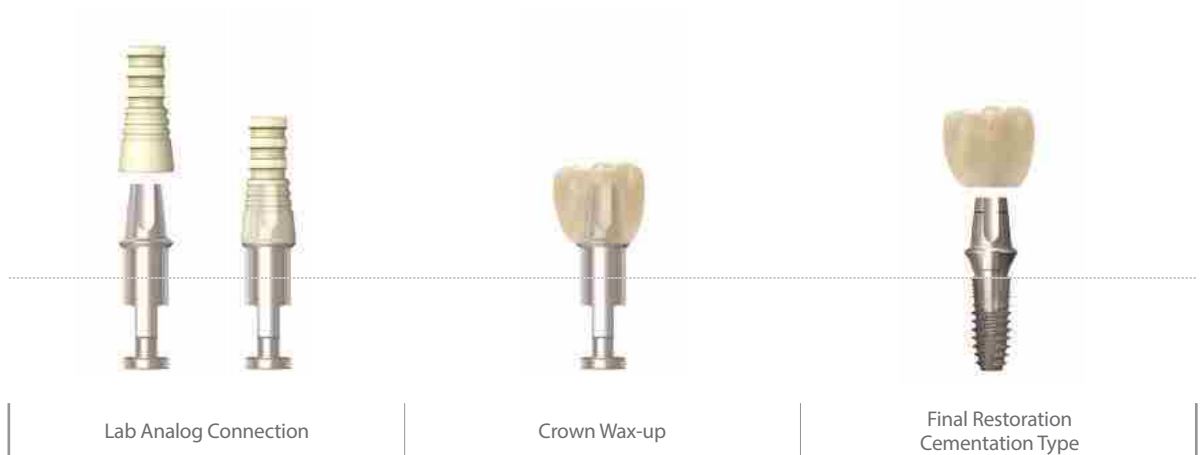

Labside

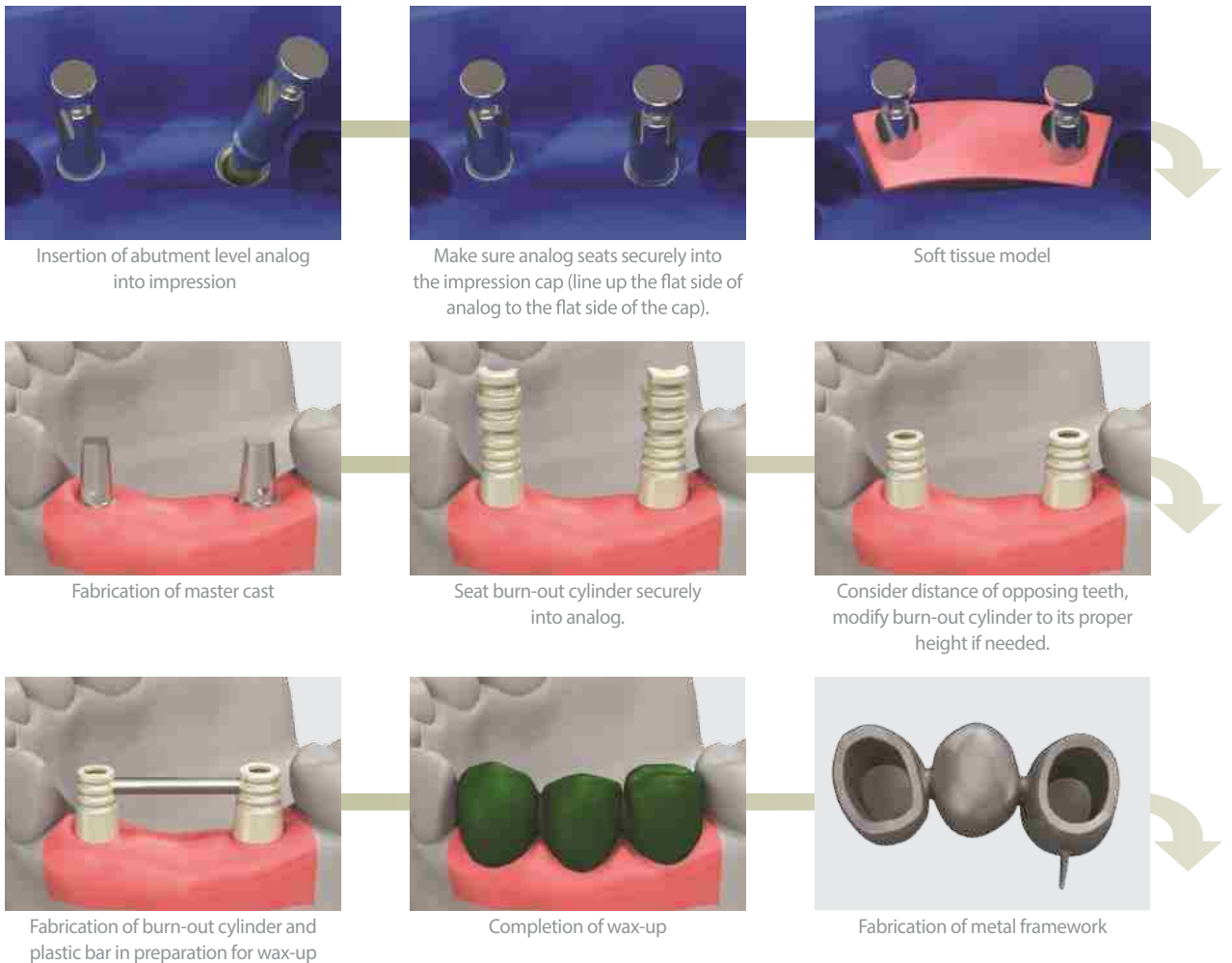

Abutment Level- Dual Abutment

[Multiple Units]



Trimming of the extended margin by using the rubber wheel



Reamer is used to eliminate "Lip" caused by 'snap-on' mechanism.

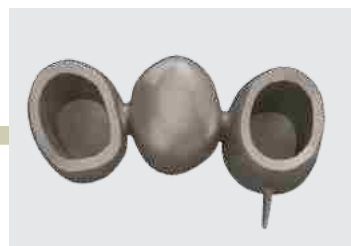

Metal framework after removal of "Lip"



Metal framework



Porcelain build-up



Final prosthesis

SCRIP: Once an access hole has been created, it can be converted to a SCRIP (Screw & Cemented Retained Prosthesis).



Access hole is made when burn-out cylinder is used to do the wax-up.



Extended margin around the metal framework due to 'snap-on' mechanism

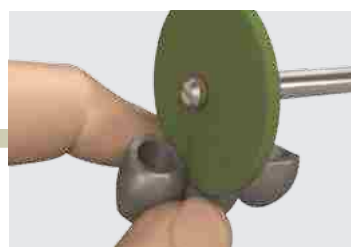

Trim extended margin by rubber wheel



Eliminate the lip remnant caused by 'snap-on' mechanism by reamer.



Metal framework after removal of "Lip"



Metal framework



Final prosthesis

Prosthetic Procedure 2

Impression Technique and Restoration Selection

Dual / Dual Milling / Angled / Metal-Casting / Temporary Abutment

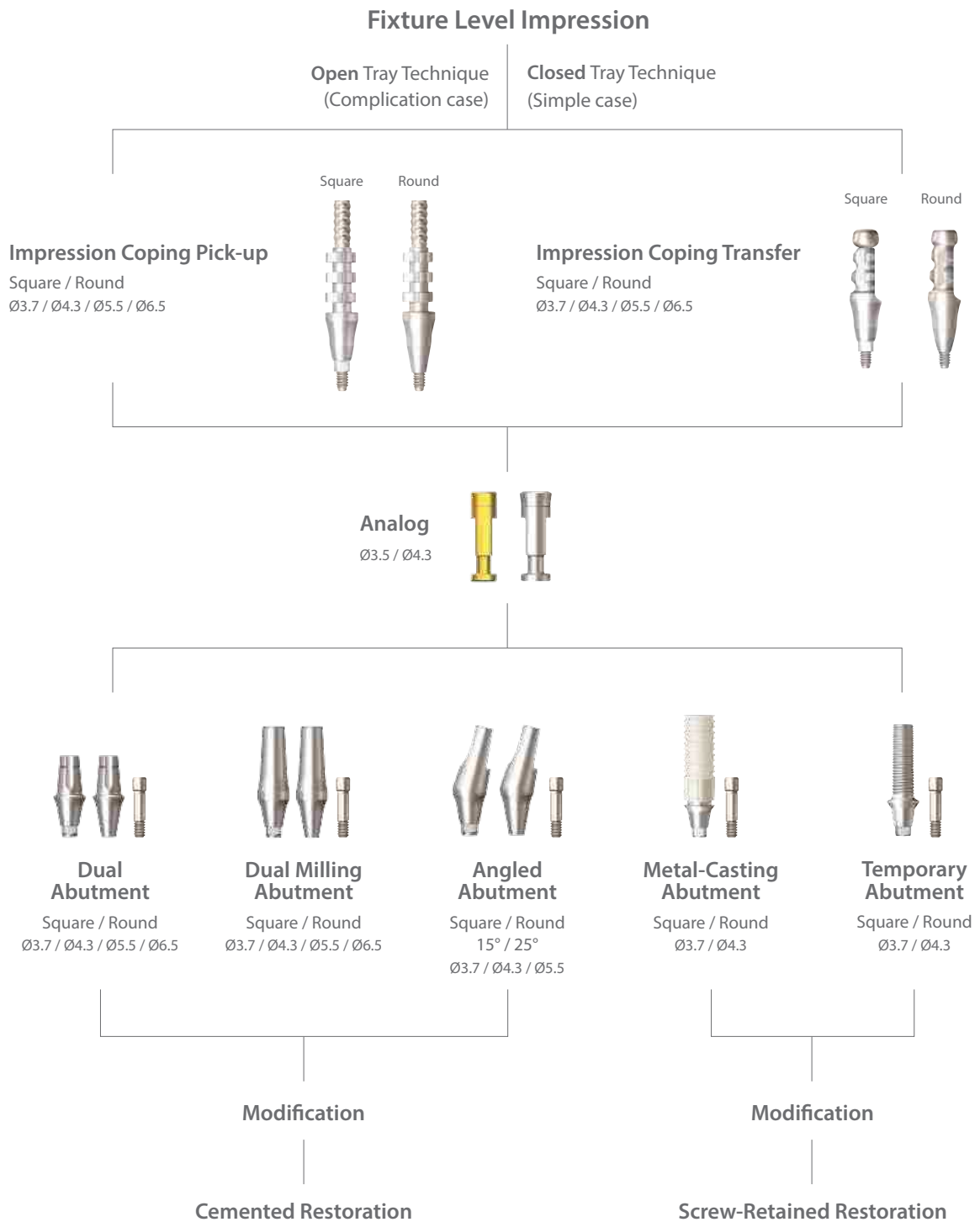

Fixture Level [Pick-up Type]- Dual Abutment

[Multiple Units]

Clinical Procedure

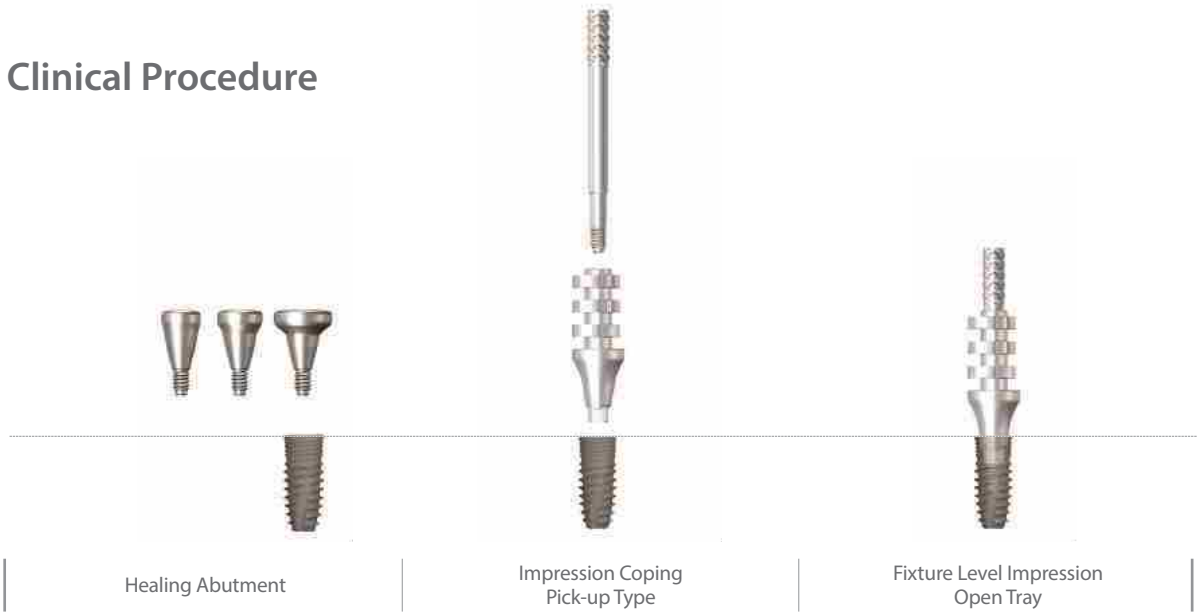

Chairside

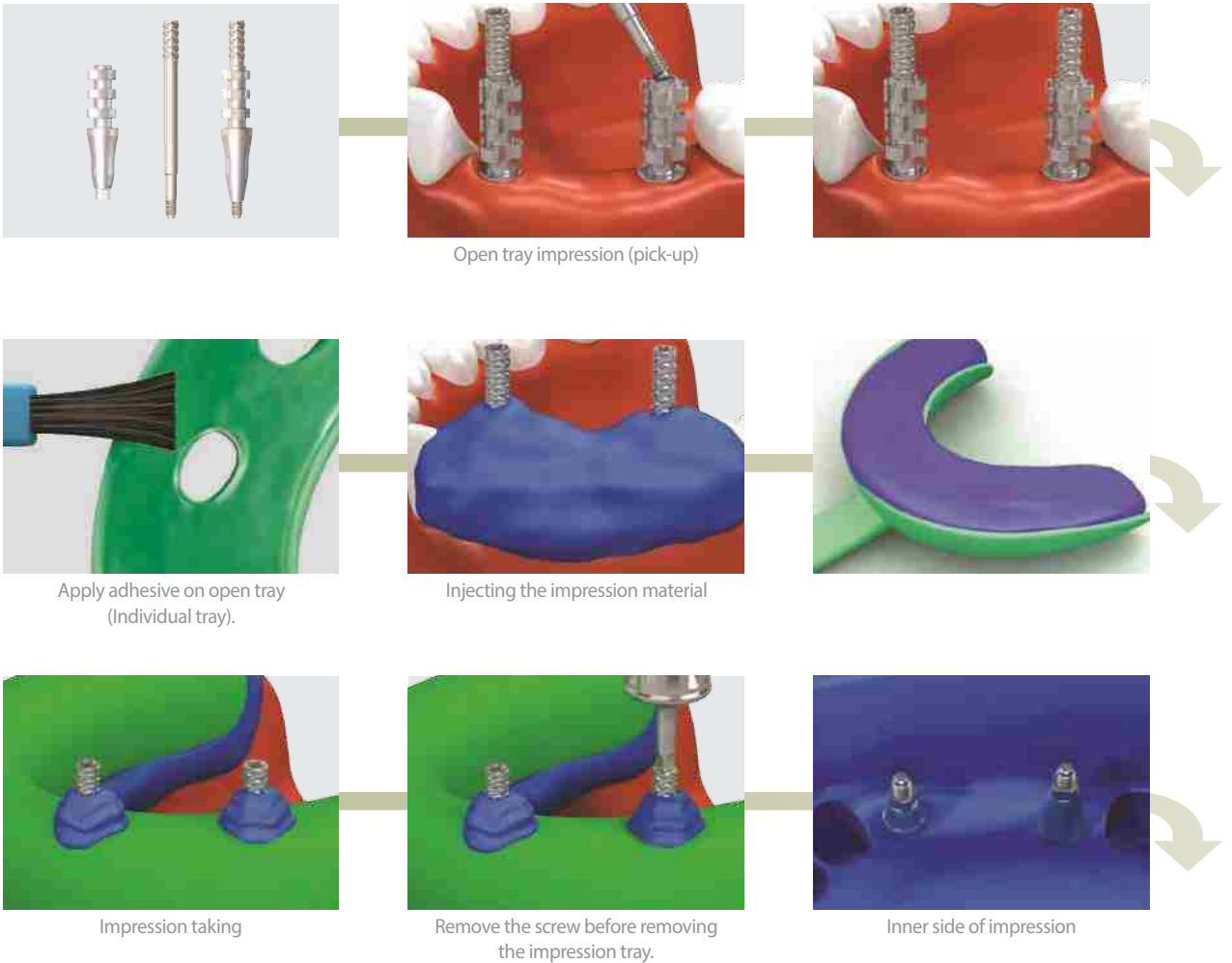

Fixture Level [Pick-up Type]- Dual Abutment

[Multiple Units]

Laboratory Procedure



Labside



Connect lab analog with impression coping.



Soft tissue model



Connect a proper abutment.



After surveying of abutment, milling is possible if necessary.



Fabrication of positioning jig



Fabrication of the cap with pattern resin



Wax-up



Metal framework



Final prosthesis

Fixture Level [Pick-up Type]- Dual Abutment

[Multiple Units]

Chairside



Use positioning jig to transfer the abutment in model to oral cavity then tighten it to 20N-cm. Retighten after 15 minutes.



Insertion of the final prosthesis and occlusal adjustment

* In the process of seating the prosthesis, the prosthesis can be rebounded by gingival tissue. In this case it is advised to apply occlusal load on the prosthesis for 10~15 minutes.

SCRP- Labside



Formation of access hole with long transfer coping screw



Wax-up



Metal framework



Final prosthesis

SCRP- Chairside



Use positioning jig to transfer the abutment in model to oral cavity then tighten it to 20N-cm. Retighten after 15 minutes.



Insertion of final prosthesis and adjustment of occlusion

* In the process of seating the prosthesis, the prosthesis can be rebounded by gingival tissue. In this case it is advised to apply occlusal load on the prosthesis for 10~15 minutes.

Fixture Level [Transfer Type]- Dual Abutment

[Multiple Units]

Clinical Procedure



Chairside

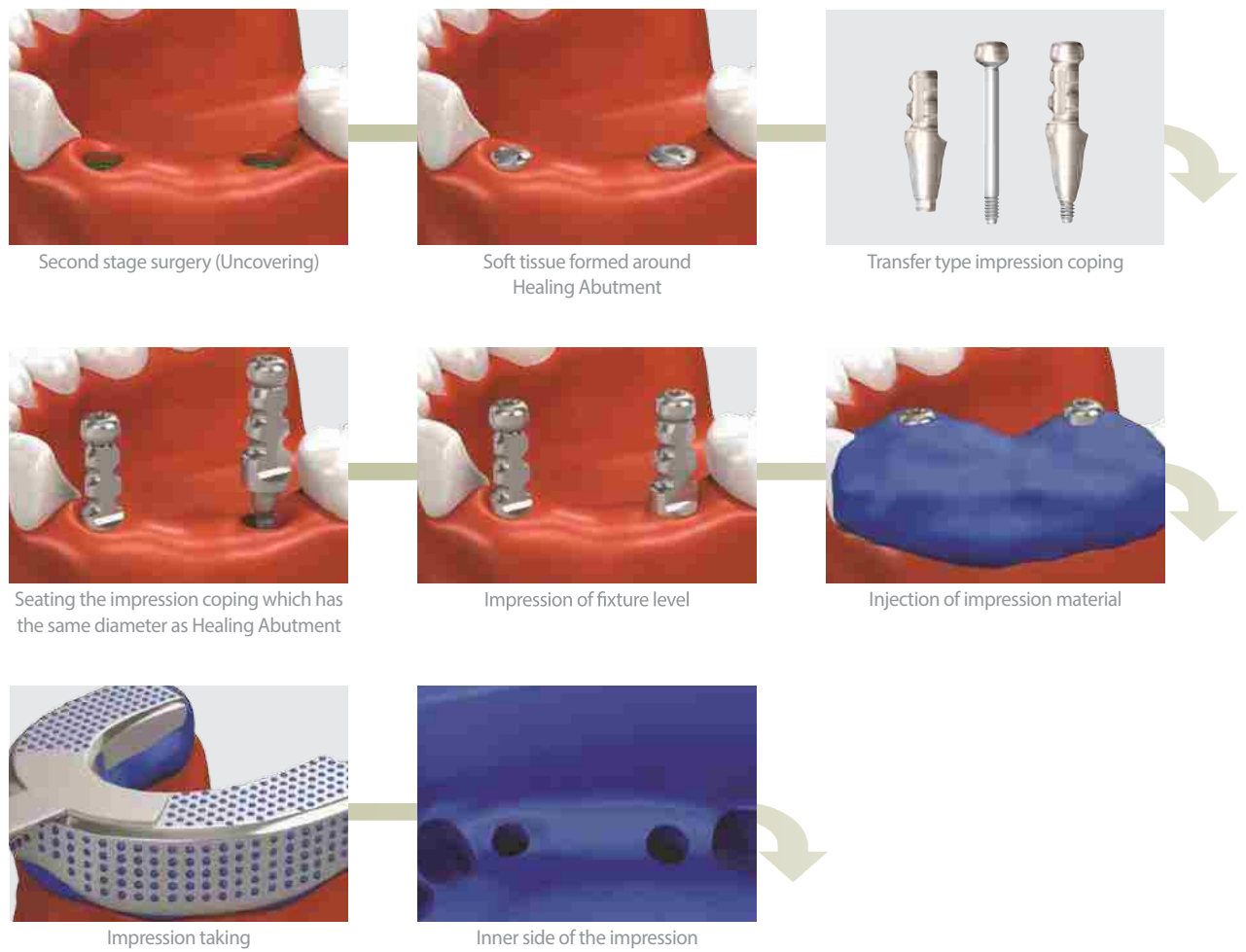

Fixture Level [Transfer Type]- Dual Abutment

[Multiple Units]

Laboratory Procedure



Labside



Impression coping and analog connection. And insert impression coping into the impression.



Make sure the impression coping is fully seated into the impression.



Soft tissue model



Fabrication of master cast



Soft tissue condition after removal of impression coping



Measuring gingival height with depth gauge



Selection of Dual Abutment of proper diameter and gingival height



Verify by surveying the selected abutment. (Milling of the abutment is possible if necessary)



Fabrication of positioning jig

Fixture Level [Transfer Type]- Dual Abutment

[Multiple Units]

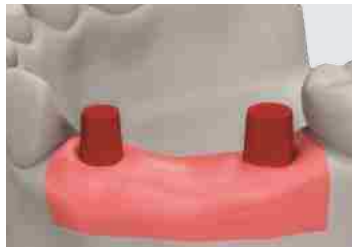

Seat the cap with pattern resin



Completion of wax-up



Completion of metal framework



Final prosthesis

Chairside



Use positioning jig to transfer the abutment in model to oral cavity then tighten it to 20N-cm. Retighten after 15 minutes.



Insertion of final prosthesis, and adjustment of occlusion. Prior to cementation, place wax into abutment screw hole to protect screw head.

SCR- Labside



Make an access hole in the resin cap by using the long transfer coping screw.



Completed wax-up



Metal framework



Final prosthesis

SCR- Chairside



Use positioning jig to transfer the abutment in model to oral cavity then tighten it to 20N-cm. Retighten after 15 minutes.



Insertion of final prosthesis and occlusal adjustment. Place wax into screw hole of the abutment prior to sealing with composite.

* In the process of seating the prosthesis, the prosthesis can be rebounded by gingival tissue. In this case it is advised to apply occlusal load on the prosthesis for 10~15 minutes.

Fixture Level [Transfer Type]- Dual Milling Abutment

[Single Unit]

Clinical Procedure

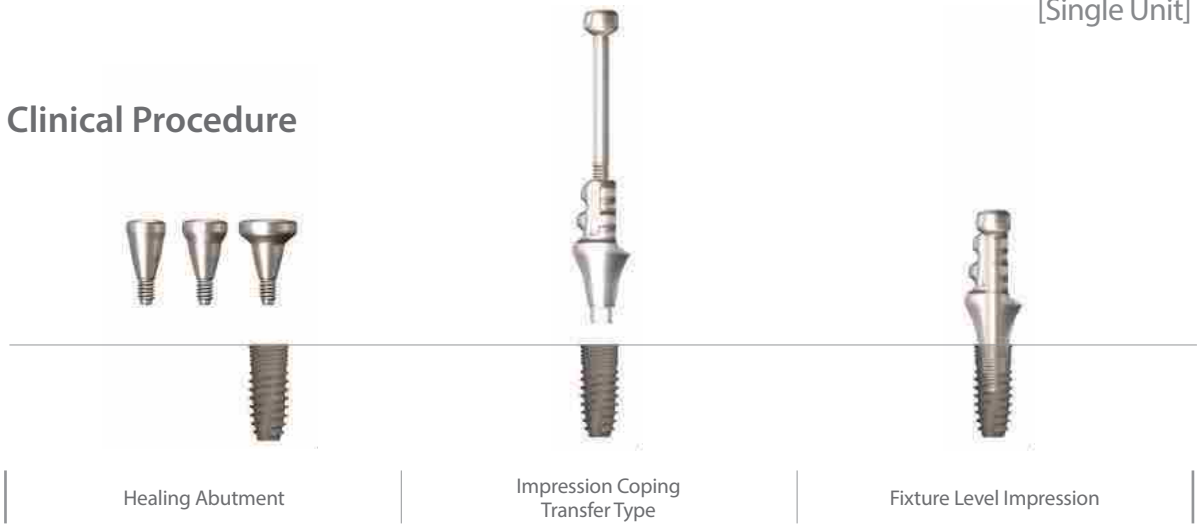

Chairside

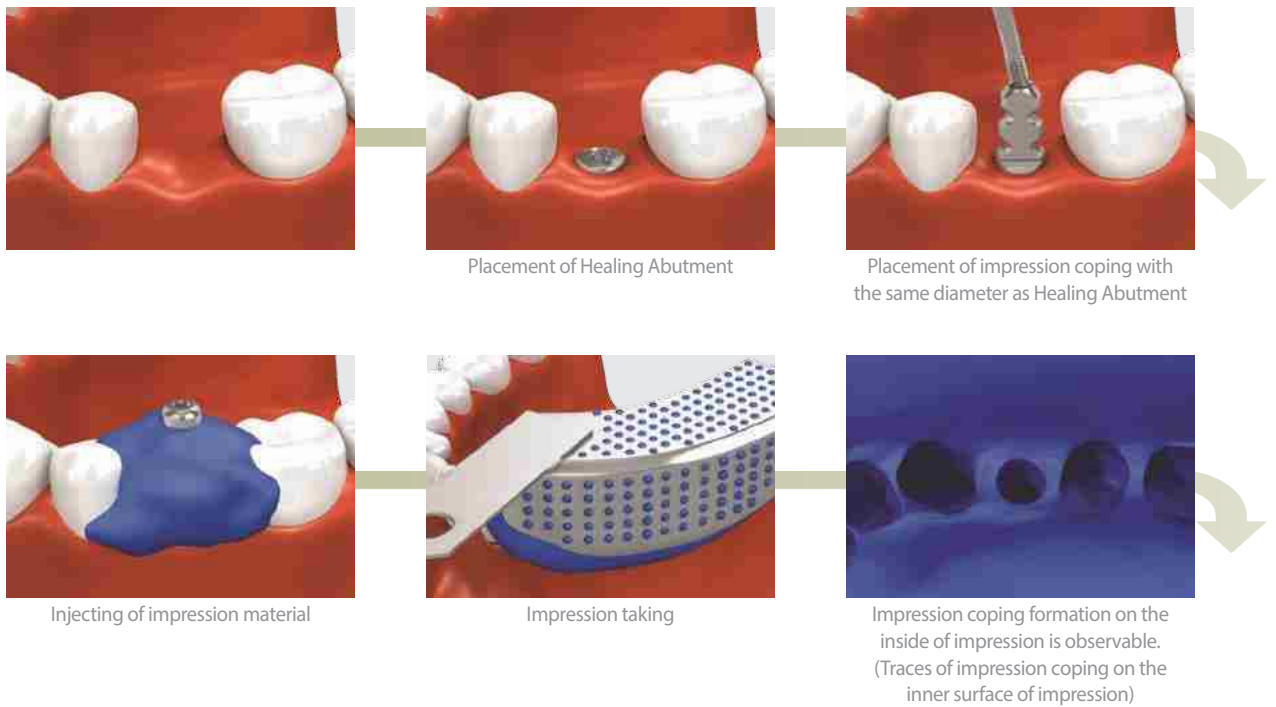

Laboratory Procedure



Fixture Level [Transfer Type]- Dual Milling Abutment

[Single Unit]

Labside



Impression coping and analog connection and insert impression coping into the impression.



Soft tissue model

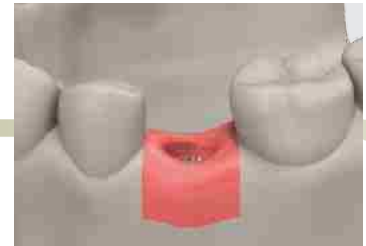

Master cast



Selection of appropriate Dual Milling Abutment



Abutment after milling process



Fabrication of positioning jig



Fabrication of pattern resin cap



Completion of wax-up



Metal framework



Final prosthesis



Use positioning jig to transfer the abutment in model to oral cavity then tighten it to 20N-cm. Retighten after 15 minutes.



Insertion of final prosthesis and occlusal adjustment

* In the process of seating the prosthesis, the prosthesis can be rebounded by gingival tissue. In this case it is advised to apply acclusal load on the prosthesis for 10~15 minutes.

Fixture Level [Pick-up Type]- Angled Abutment

[Single Unit]

Clinical Procedure

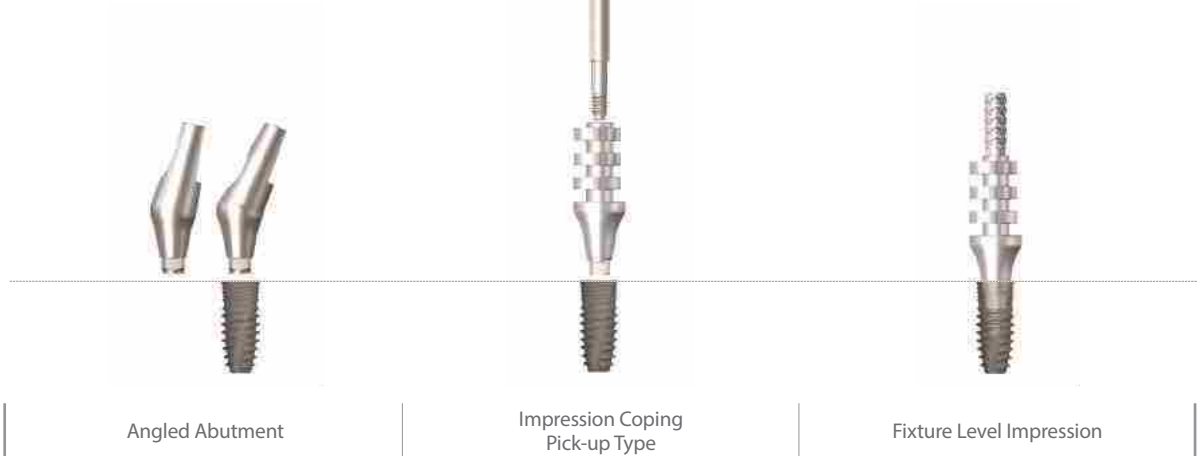

Chairside

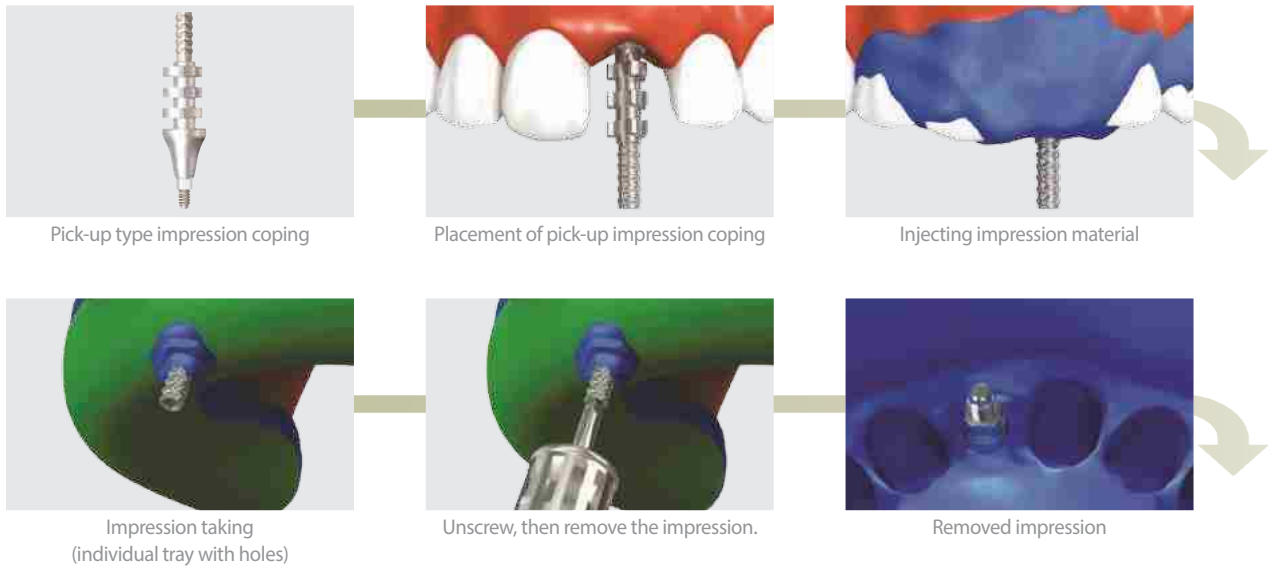

Laboratory Procedure

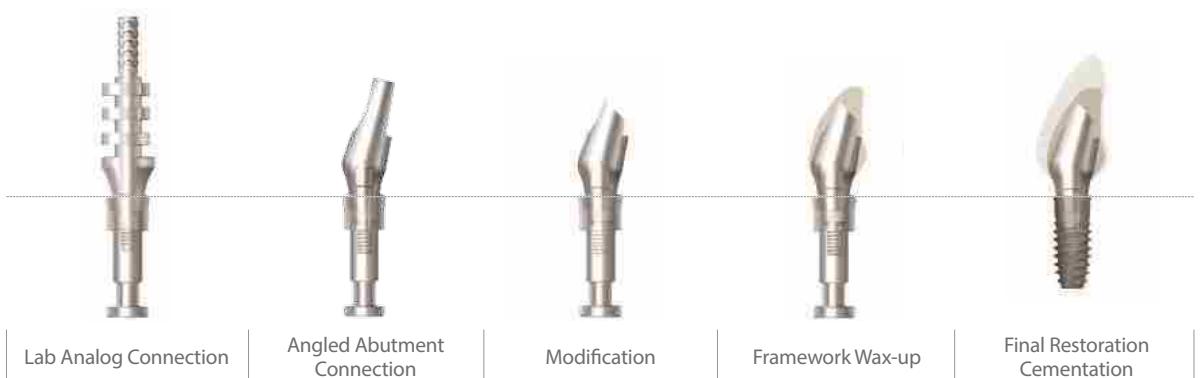

Fixture Level [Pick-up Type]- Angled Abutment

[Single Unit]

Labside



Impression coping with analog connections



Soft tissue formation and fabrication of master model



Unscrew then separate impression from the model.



Master cast



Select an Angled Abutment.

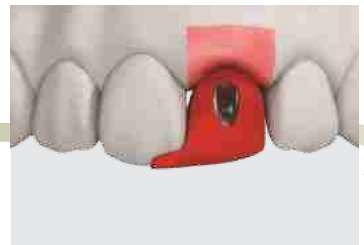

Modification of Angled Abutment & fabrication of positioning jig



Fabrication of pattern resin cap



Wax-up



Metal or zirconia framework

Chairside



Final prosthesis



Insertion of the Angled Abutment using positioning jig



Insertion of final prosthesis and occlusal adjustment

Fixture Level- Metal-Casting Abutment

[Single Unit]

Laboratory Procedure



Labside

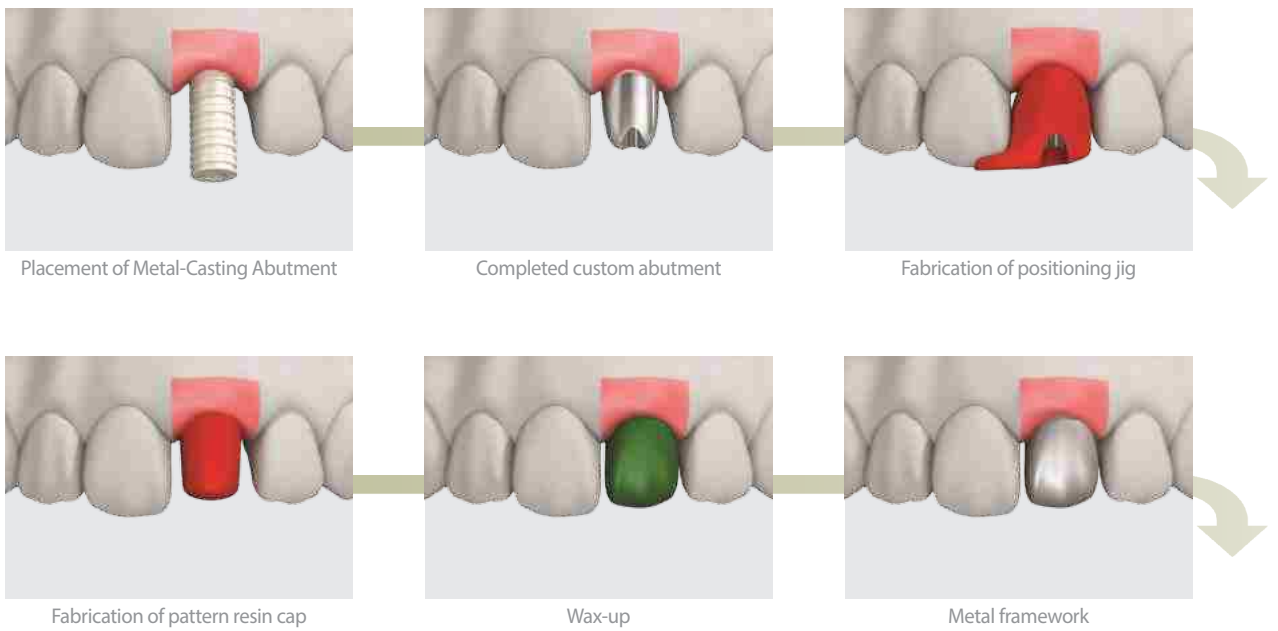

Chairside



Fixture Level [Pick-up Type]- Temporary Abutment

[Single Unit]



Temporary Abutment

<Using Temporary Abutment>



Considering the opposing teeth before seating the Temporary Abutment, trim off the abutment if needed and complete the Temporary Abutment prosthesis with direct resin.

Prosthetic Procedure 3

Impression Technique and Restoration Selection

Screw Abutment

Abutment Level Impression

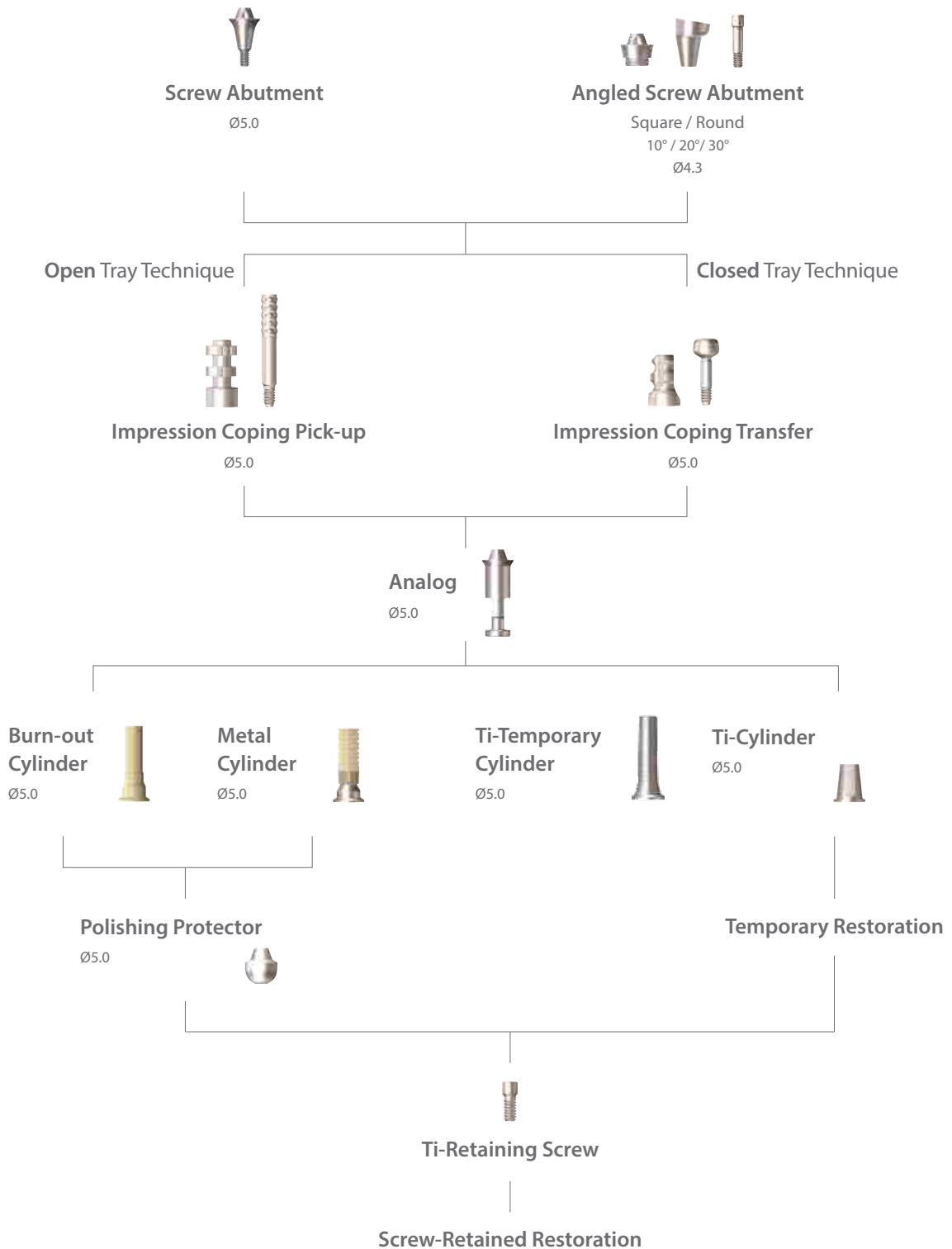

Abutment Level [Transfer Type]- Screw Abutment

[Multiple Units]

Clinical Procedure

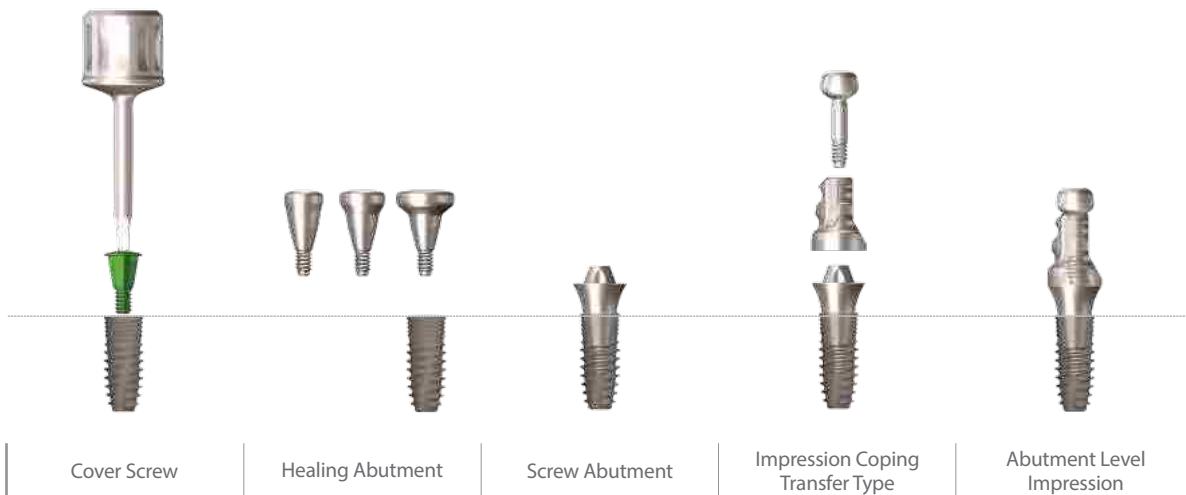

Chairside

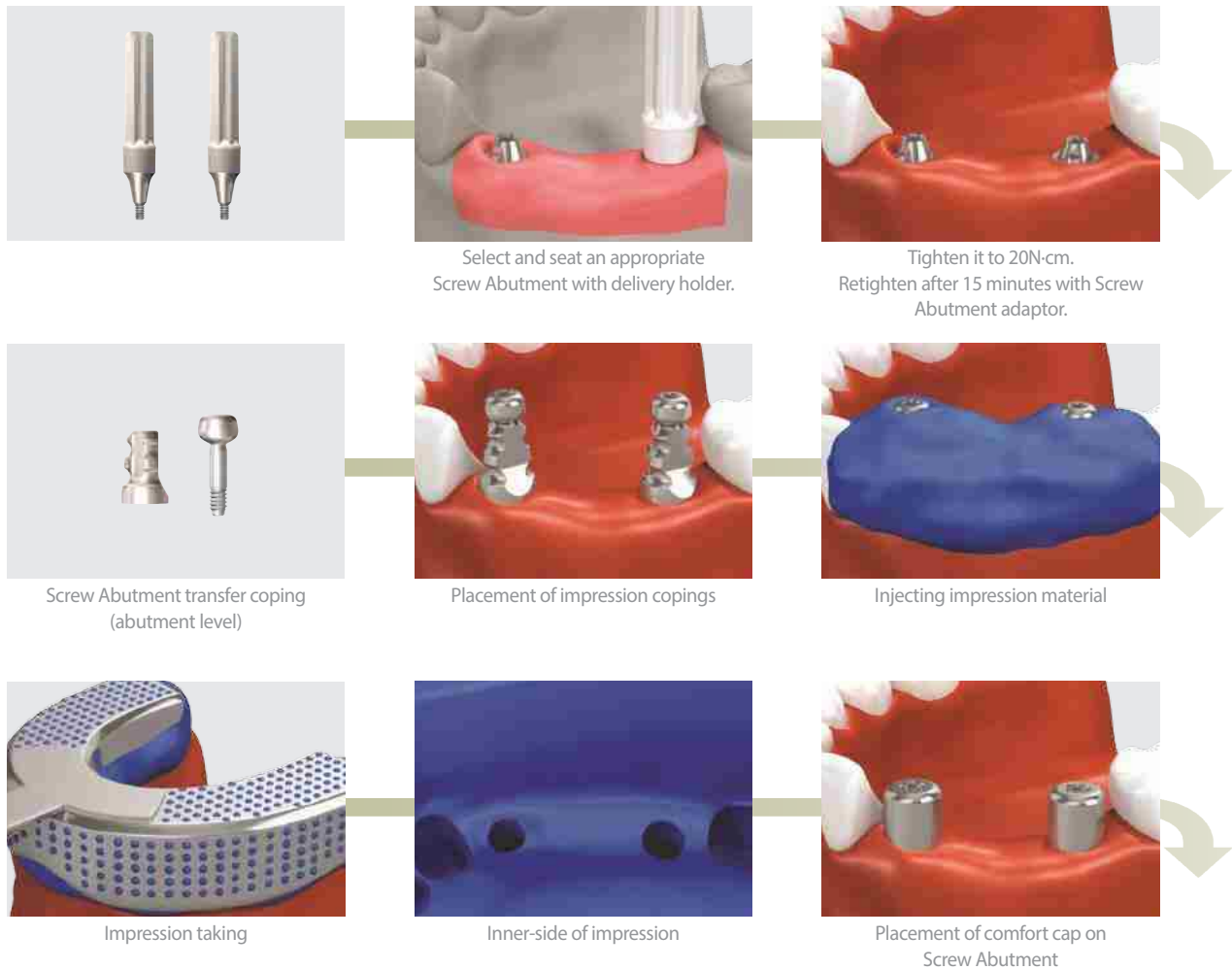

Abutment Level [Transfer Type]- Screw Abutment

[Multiple Units]

Laboratory Procedure

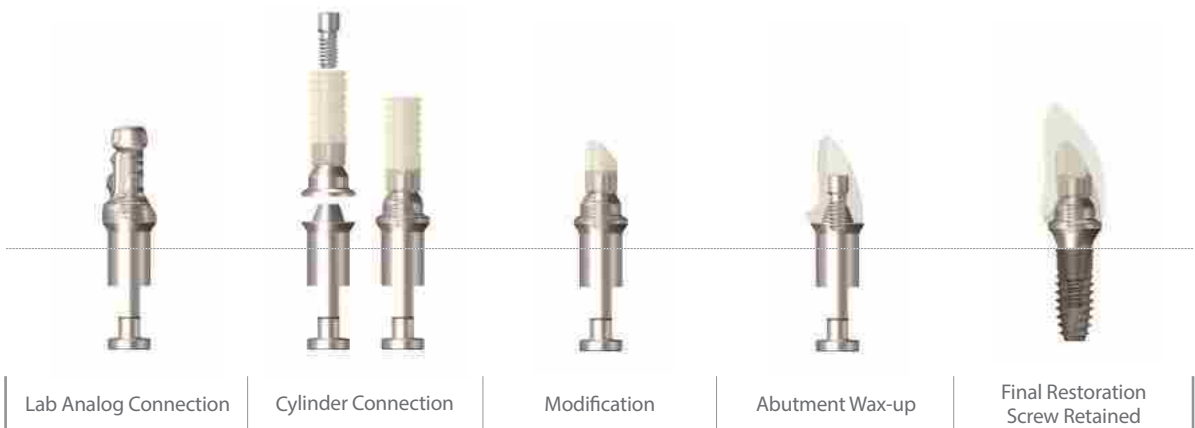

Labside



Connecting impression coping with Screw Abutment analog



Positioning impression coping and analog assembly in the exact location of the impression



Soft tissue model



Fabrication of master cast



Removal of impression coping



Connect the Screw Abutment cylinder then tighten it with ti-retaining screw.



Consider the distance with opposing teeth, then trim cylinder to its appropriate height.



Connect the plastic bar in the middle of trimmed Screw Abutment to help support the wax pattern. Wax pattern may have shrinkage.



Wax-up

Abutment Level [Transfer Type]- Screw Abutment

[Multiple Units]



Metal framework

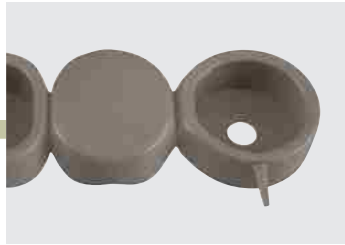

Removal of lip remnant in the interior of metal framework using reamer



Completion of metal framework



Completion of final prosthesis



Insertion of final prosthesis and occlusal adjustment. Tighten with ti-retaining screw (20N-cm).

Cementation Repair Method (SCRCP)

[Screw & Cement Retained Prosthesis]

In Light of Implant Prosthesis:

- A screw type restoration helps to simplify prosthesis repair, including insertion and removal of the prosthesis if necessary.
- Cement type restoration tend to have a stable occlusion and may enhance the adaptability. However the weak point is that it cannot be removed after permanent cementation.
- A dual abutment can be cemented or screw retained.

In Case of Screw Loosening or if Prosthesis Repair is Needed



In case of the following:
screw loosening or prosthesis repair



In order to unscrew, form access hole on the occlusal surface with bur.



Unscrew, then remove the prosthesis from the oral cavity.



Both cemented prosthesis and abutment are removed.



Finish the repair then seat it inside the oral cavity.



Tighten the prosthesis with 20N-cm by a screw driver
* It is recommended that the abutment screw is retightened after 15 minutes.



Fill the access hole with cotton.

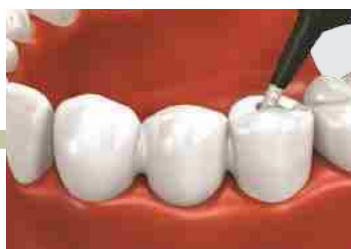

Fill the access hole with resin.



Final prosthesis

Cementation Repair Method (SCRIP)

[Screw & Cement Retained Prosthesis]

Separation of Prosthesis with Abutment due to Cement Loss



Remove the screw completely with square driver and remove prosthesis from the patient's mouth.



Apply cement to the prosthesis.

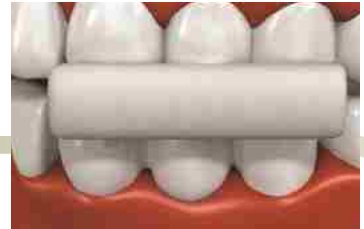

Place it back into the patient's mouth.



After the cement setting, unscrew and remove the excessive cement.



Finish the repair and seat it inside the patient's mouth.



Tighten the prosthesis with 20N-cm with a screw driver.

Adding to the Interproximal Contact Surface due to Prosthesis Loosening



Prosthesis loosening due to contact loosening.



Form access hole using bur.



Unscrew, then remove the cemented prosthesis with abutment in the oral cavity.

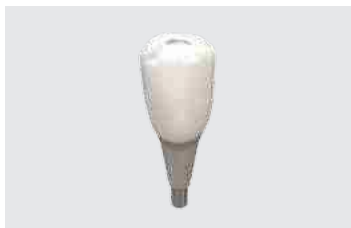

Contact adding with resin on the prepared under space.



Insert the prosthesis in the oral cavity and screw it in afterwards perform light curing. And then polish the contact area. It is recommended that the abutment screw is retightened after 15 minutes.



Position the prosthesis in the oral cavity and tighten the screw with 20N-cm, then fill up the access hole.



Prosthetic Procedure 4

Impression Technique and Restoration Selection

Overdenture Procedure Mini Ball / Magnetic Attachment

Abutment Level Impression

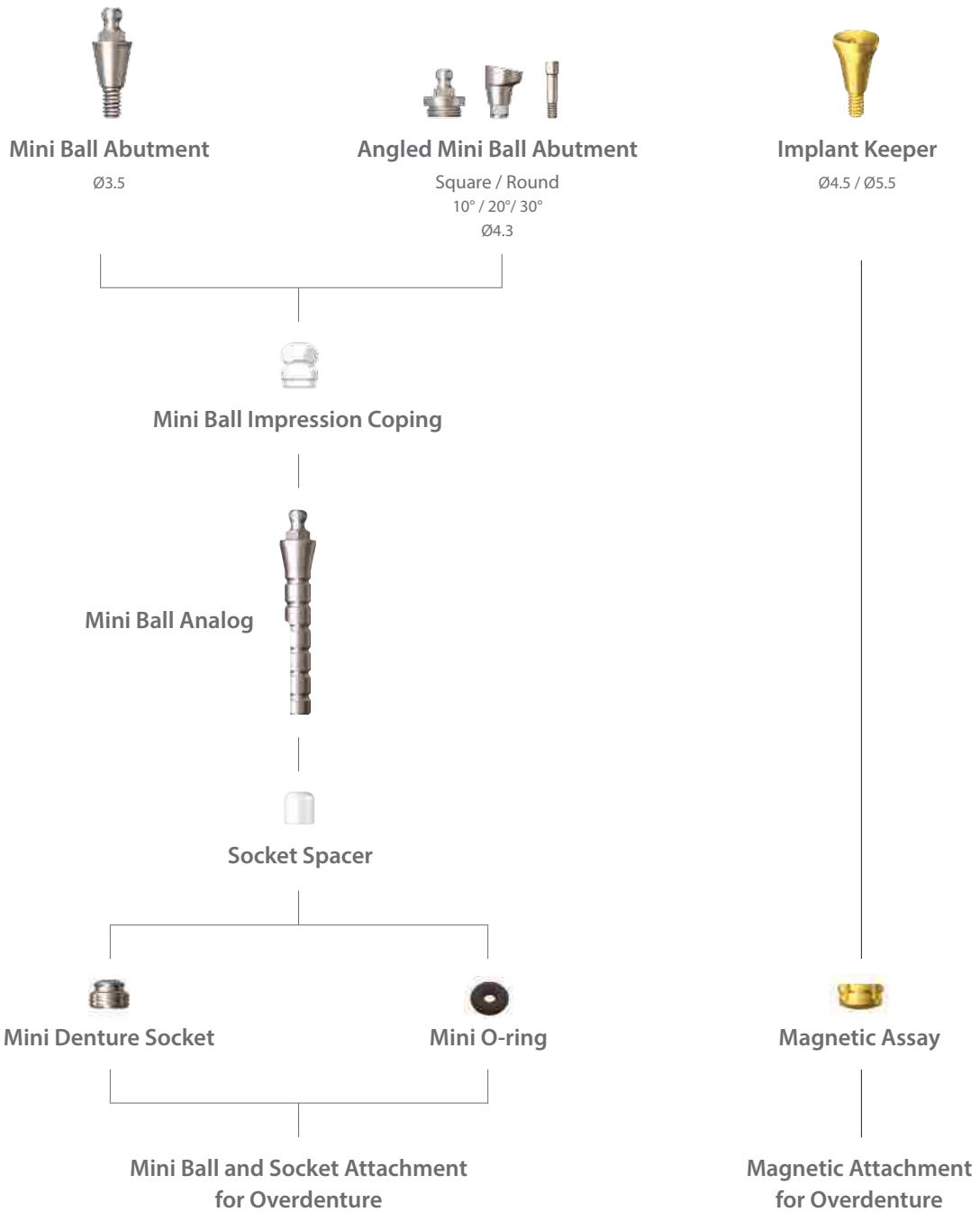

Mini Ball Attachment

Chairside



Connect the Mini Ball Abutment onto the fixture.



Affix the impression coping on the Mini Ball Abutment.

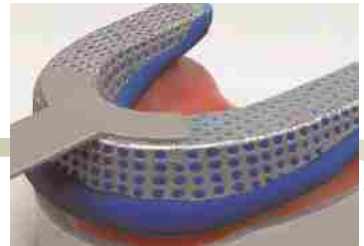

Take impression for the making of individual tray.



Produce the individual tray for denture impression.

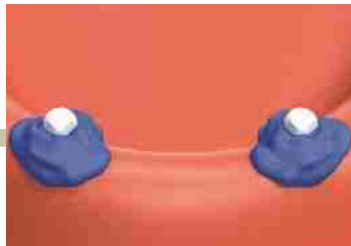

Apply the impression material.



Take the final impression with the prepared individual tray.

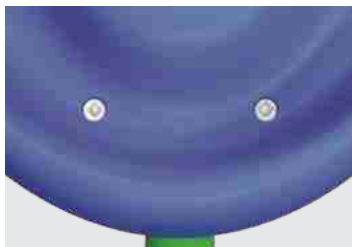

After the impression material is set, discard the individual tray.

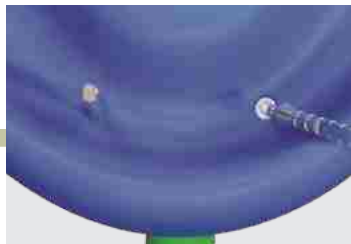

Image of the final impression (with impression coping)

Labside



Mini Ball Analog



Insert analogs into the embedded impression coping.



Create the master model.



Socket spacer



Fabrication of denture with conventional method

Mini Ball Attachment

Case 1



Secure spaces for the female sockets.

Chairside



Connect the female sockets to the Mini Ball Abutments in the intra-oral.



Apply small amount of the resin into the secured area.



Position the denture in the oral cavity and wait until the resin is completely set.



Female sockets are placed in the denture.



After polishing, the overdenture is completed.

Case 2



Create holes for placement of female sockets.

Chairside



Connect the female sockets to the Mini Ball Abutments in the intra-oral.



Examine the interference between inner surface of the holes and the female sockets.



Apply the resin into the holes and wait until it is completely set.



Female sockets are placed in the denture.



Apply resin around the female sockets.



After polishing, the overdenture is completed.

Angled Mini Ball Attachment

Case 1



Secure spaces for the female sockets.



Apply small amount of the resin into the secured area.



After polishing, the overdenture is completed.

Chairside



Connect the female sockets to the Angled Mini Ball Abutments in the intra-oral.



Position the denture in the oral cavity and wait until the resin is completely set.



Female sockets are placed in the denture.

Angled Mini Ball Attachment

Case 2



Create holes for placement of female sockets.



Examine the interference between inner surface of the holes and the female sockets.



Apply resin around the female sockets.

Chairside



Connect the female sockets to the Angled Mini Ball Abutments in the intra-oral.



Apply the resin into the holes and wait until it is completely set.



Female sockets are placed in the denture.



After polishing, the overdenture is completed.

Magnetic Attachment

Chairside

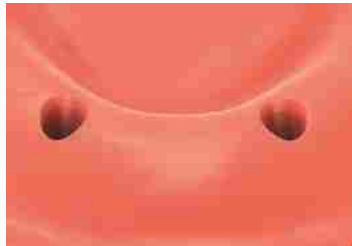

After Healing Abutment removal



Connect implant keeper with fixture and tighten it with 20N-cm.



Implant keepers connected with the fixtures



Position the Magnetic Assay on the implant keeper.



Secure spaces for the Magnetic Assays.



Examine the interference between inner divot of the denture and the magnets.

Case 1



Apply resin on the divot of the denture's inner surface.



Position the denture into the mouth and wait until the resin is completely set.



Magnetic Assays are placed in the denture.



Apply some of resin around the Magnetic Assays.



After the resin is completely set, remove excess. After polishing, the overdenture is completed.

Magnetic Attachment

Case 2



Create holes for the placement of the magnets.



Examine the interference between inner surface of the holes and the magnets.



Position the denture in the mouth and apply small amount of resin into the hole.



Wait until the resin is completely set.



After setting, remove denture from the mouth.



Add the resin around the magnets.



After polishing, the overdenture is completed.

Dentium
For Dentists By Dentists

NR Line

Product/Manual Catalog

Dentium
For Dentists By Dentists

Specifications are subject to change without any notice.
Some products listed in this catalog are not available in the market due to pending approval.

HEAD OFFICE

501 Gyeonggi R&DB Center, 105 Gwanggyo-ro, Yeongtong-gu, Suwon-si, Gyeonggi-do, Korea [16229]

T +82-31-888-5431 F +82-31-888-5430

E-mail biz_mail@dentium.com / www.dentium.com

NRPMC-1804 [Rev.0]