

Dentium Instruments
for Total Solution

Catalog & Manual

Index

Surgical Guide	Polymer Guide	04
	Implant Guide	06
Sinus Instruments	DASK	11
	Osteotome Kit	16
	Sinus Elevator	17
GBR Instruments	RS Kit	19
	Harvest Drill	24
Others	Help Kit	27
	Temporary Shell	34
	White Seal	36
	TN-Brush	40

The image shows a dental surgical guide on a model. The guide is a clear, semi-transparent plastic structure with a central hole. A metal drill bit is inserted into this hole. The background is a soft, out-of-focus light blue. The text 'Surgical Guide' is printed in white, bold font in the lower right quadrant. Below it, 'Polymer Guide' and 'Implant Guide' are written in a smaller, red, italicized font.

Surgical Guide

*Polymer Guide
Implant Guide*

Polymer Guide

Thermoplastic Surgical Template for Dental Implant Placement

- Fabricate precise surgical template in just minutes using hot water
- Disposable material to promote control of infection and contamination
- Titanium sleeve is compatible with Dentium Guide and Final Drills



Thermoplastic surgical template
Fabricate an accurate surgical template in just minutes, greatly reducing the lab and chairside time

Fully compatible with Dentium drill system

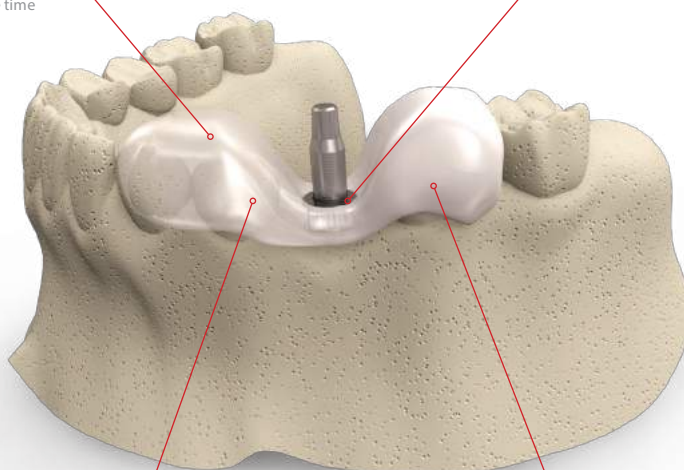

Suitable template shape

Polymer Guide is designed to maximize contact area over the adjacent teeth while allowing substantial field of view during implant surgery

Improved infection/contamination control

To ensure infection/contamination-free surgery every time, the Polymer Guide is made to be disposable



Drill a hole in the stone model



Insert the Guide Pin



Soak the Polymer Guide in hot water above 65°C to soften up the material for easy molding



Apply of Polymer Guide on stone model



Remove the Guide Pin



Position the Polymer Guide intra-orally for drilling

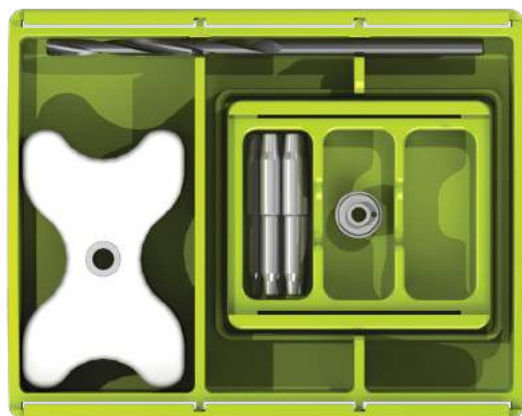

PGSSK



PGSCK

Single Standard (5ea)

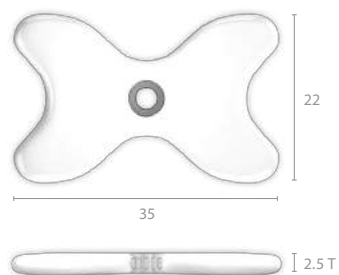



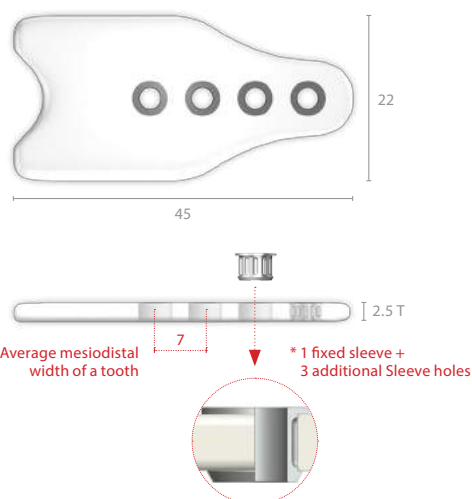

Cantilever Multi-Ready (5ea)



[Unit: mm, Scale 1 : 1]

T	Art. No.
2.5	XSG 34 35 S

T	Art. No.
2.5	XSG 34 45 C

	Type	Art. No.	PGSSK	PGSCK
	Stone Drill	XGD 23 60	1ea	1ea
	Guide Pin	XGP 34 23 S	5ea	5ea
	Guide Drill Brushing (First)	XPGB 19 26	1ea	1ea
	Guide Drill Brushing (Second)	XPGB 26 34	1ea	1ea
	Additional Metal Sleeve (for Cantilever Multi-Ready)	XPGS 34 25 A	X	5ea

Implant Guide

Surgical guide utilizing silicon spacer and unique parallel pin

- The tripod parallel pin is designed to take into consideration the mesiodistal width and drilling position in the edentulous area
- Parallel pins and Spacers are configured based on the average width of a tooth



Assist in the implant positioning as well as determining the width and the position of the prosthetic components

The Guide Drill holes on the Tripod Parallel Pin help in prepping the osteotomy in the correct orientation

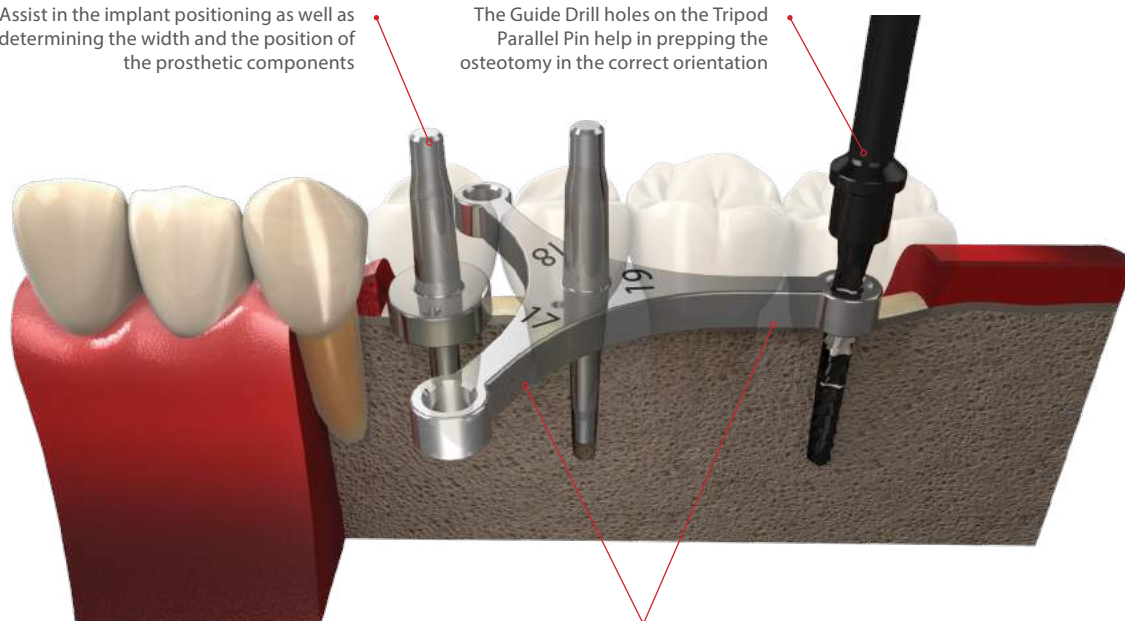

The three legs of the Tripod Parallel Pin are of different lengths to accommodate varying widths of prosthesis for multiple unit bridges



Spacer + Guide Drill

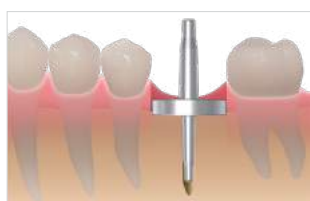

Ellipse Parallel Pin



Final prosthesis



Spacer + Guide Drill



Ellipse Parallel Pin + Tripod Parallel Pin



Final prosthesis

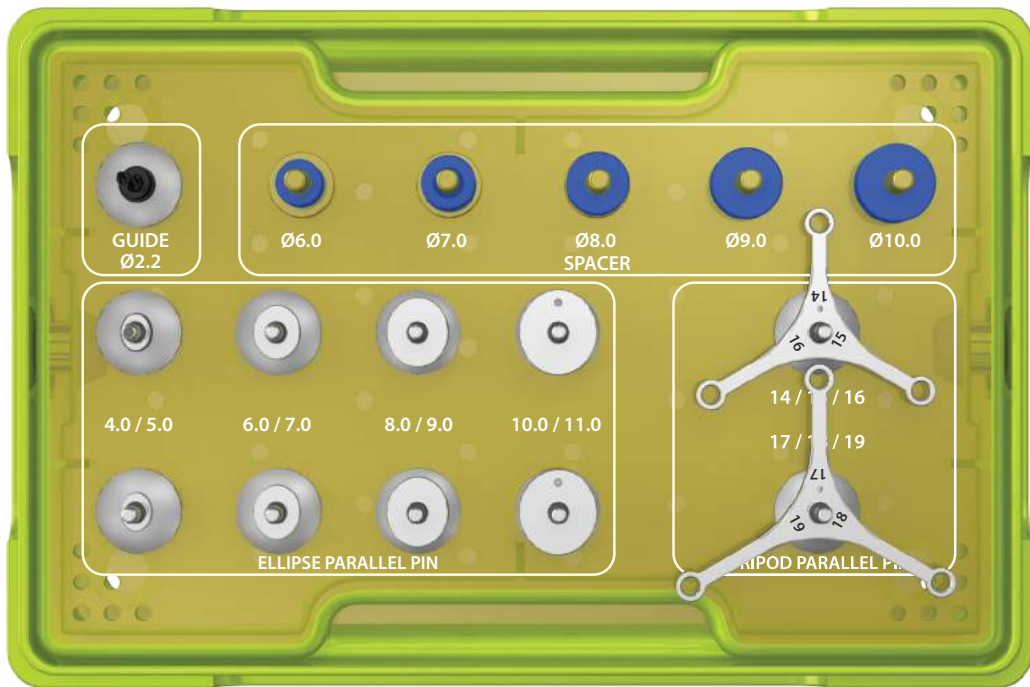

ISGK

Kit Contents

Guide Drill



XLD 22 355

Spacers



XLDSP 605 XLDSP 705 XLDSP 805 XLDSP 905 XLDSP 015

Ellipse Parallel Pins (x2)



XPP 2226 50G XPP 2226 70G XPP 2226 90G XPP 2226 11G

Tripod Parallel Pins

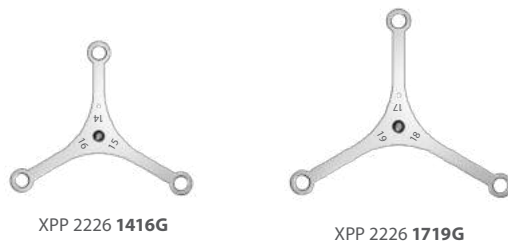

XPP 2226 1416G

XPP 2226 1719G

Spacers

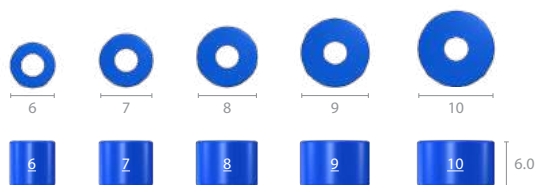

Diameter	Art. No.
Ø 6	XLDSP 60S
Ø 7	XLDSP 70S
Ø 8	XLDSP 80S
Ø 9	XLDSP 90S
Ø 10	XLDSP 01S

Ellipse Parallel Pins

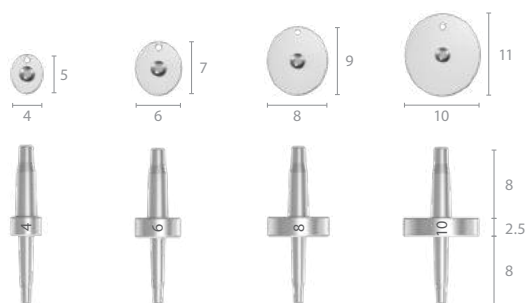

Diameter	Art. No.
Ø 4 / Ø 5	XPP 2226 50G
Ø 6 / Ø 7	XPP 2226 70G
Ø 8 / Ø 9	XPP 2226 90G
Ø 10 / Ø 11	XPP 2226 11G

Tripod Parallel Pins

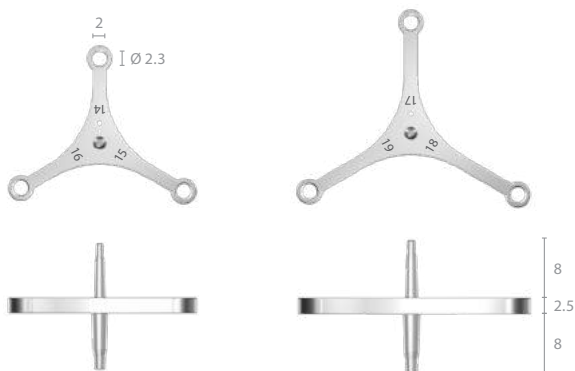

Width	Art. No.
14 / 15 / 16	XPP 2226 1416G
17 / 18 / 19	XPP 2226 1719G

Single Case

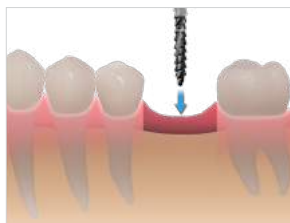

Incision



Guide Drill
Combination of Guide Drill and
Spacer

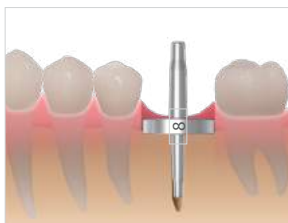

Ellipse Parallel Pin



Final Drill



Countersink



Fixture placement with
Healing Abutment
SuperLine



Dual Abutment Connection



Final prosthesis

Multiple Case

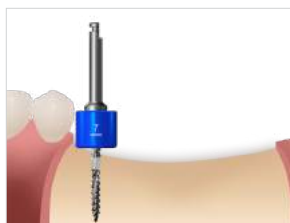

Guide Drill
Combination of Guide Drill and
Spacer

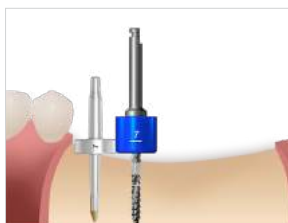

Guide Drill
Application of Tripod and Ellipse Parallel Pin

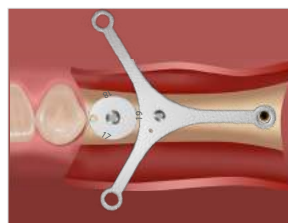
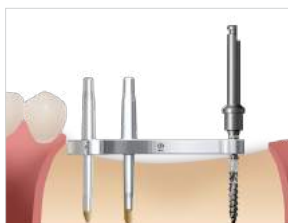

Final Drilling



Fixture placement with
Healing Abutment



Dual Abutment connection



Final prosthesis



Sinus Instruments

*DASK
Osteotome Kit
Sinus Elevator*

Dentium Advanced Sinus Kit (DASK)

- Simple & easy access to sinus cavity
- Broad exposure of bony walls with special instruments

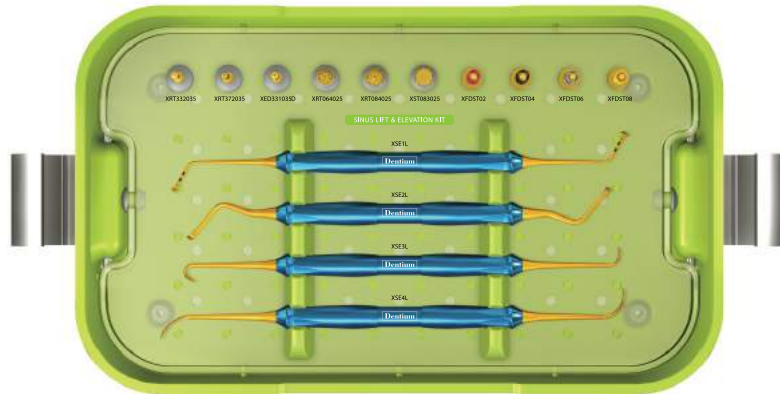

DASK Drills



[Unit: mm, Scale 1.2 : 1]

Type	DASK Drill #	REF
Crestal Approach	DASK Drill # 1	XRT 332035
	DASK Drill # 2	XRT 372035
	DASK Drill # 3	XED 331035D
Lateral Approach	DASK Drill # 4	XRT 064025
	DASK Drill # 5	XRT 084025
	DASK Drill # 6	XRT 083025

* Note: Drill speed 800 to 1,200rpm, 30~45N-cm with irrigation

Stoppers | for XRT332035, XRT372035, XED331035D



[Unit: mm, Scale 1 : 1]

Drilling Depth	L	REF
08	10.6	XFDST 08
06	12.6	XFDST 06
04	14.6	XFDST 04
02	16.6	XFDST 02

Sinus Bur Kit



SDK

Sinus Elevation Instruments

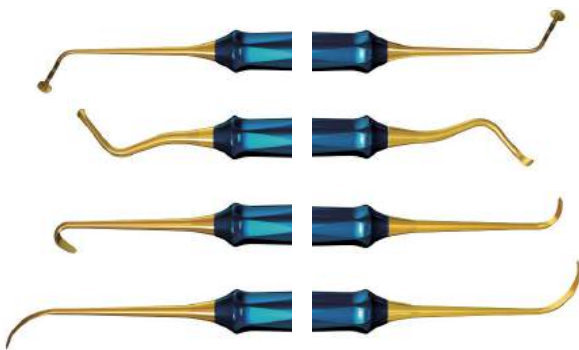

[Unit: mm, Scale 0.68 : 1]

REF	XSE1L
REF	XSE2L
REF	XSE3L
REF	XSE4L

Drills for Crestal Approach



DASK Drill #1
XRT332035



DASK Drill #2
XRT372035

[800~1,200 rpm]



DASK Drill #3
XED331035D

[800~1,200 rpm]

The distance from the alveolar crest to the sinus floor should be measured on x-rays prior to surgery. Site preparation is performed with final drills in sequence up to 1mm short of the sinus floor. Then **DASK Drill #1** or **#2** is used and the sinus floor is carefully approached with light apical pressure. When you feel the yielding of the sinus floor, remove the drill. Or, partial preparations with DASK Drill #1 or #2 and up-fracture with osteotomes can be performed

When the sinus cavity is accessed, **DASK Drill #3** is introduced and a much broader detachment from the sinus floor can be facilitated horizontally with hydraulic pressure thanks to the internal irrigation hole

DASK Drill #3 can also be used for a lateral approach surgery.

Drills for Lateral Approach



DASK Drill #4
XRT064025



DASK Drill #5
XRT084025

[800~1,200 rpm]



DASK Drill #6
XST083025

[800~1,200 rpm]

To make a lateral window through the antrostomy (thin-out) approach

To make a lateral window through the wall-off technique

DASK Maintenance

Sterilization and Instrument Care Procedures

- Please follow for legal regulations, as well as hygienic guidelines to prevent contamination and infection
 - Please remember that you are responsible for the maintenance and sterility of your medical/dental products/device
 - It is important to use and follow, proper cleaning, disinfection and sterilization procedures
 - It is also important to follow the manufacturer's recommendation on use of drills
 - Please keep a log as to how many times the drills were used
 - Drill usage is determined by surgical site not per patient. Bone density and usage determine the life of the drills
 - Drills should be considered for replacement after approximately 15- 20 uses based on bone density. Check drills frequently for wear
1. All instruments, immediately after use, must be presoaked for a few minutes in a germicidal bath to loosen and prevent debris from attaching to instruments. Do not soak overnight
 2. Scrub with a soft brush to remove any debris
 3. For internal irrigation drills, use a reamer or small gauge needle to internally cleanout the drills
 4. Before using an ultrasonic cleaner, wrap drills in a 2 x 2 gauze to prevent rubbing against each other
 5. Rinse thoroughly with warm water
 6. Clean all instrument trays with a germicidal cleaner prior to replacing instruments in kit
 7. Dry completely and place back into kit
 8. Always check for damage or corrosion after rinsing and drying
 9. Seal the tray in a sterilization pouch
 10. Sterilize using a steam autoclave in 121°C/250F for 30 minutes or refer to manufacturer's recommendations
 11. Store in a dry area at room temperature

Crestal Approach (Sinus Lifting)



After Ø3.8 Final drilling, eliminate the residual bone (1mm) using a DASK Drill #1 or #2 (in hard bone) until you feel a slight drop

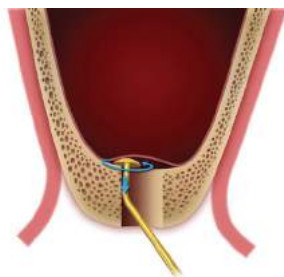

Detach sinus membran using the dome-shape sinus curette

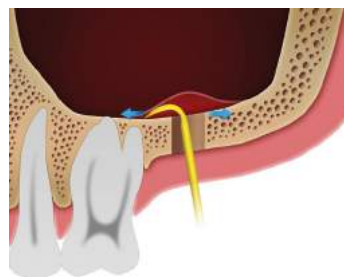

Detaching the sinus membrane to create adequate space for graft material



Fill the sinus cavity with [OSTEON™ Lifting] graft material

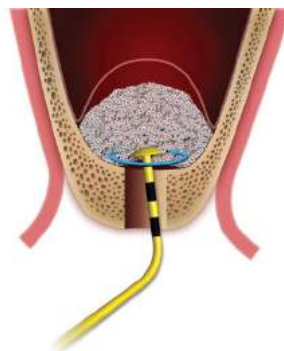

Fill and distribute OSTEON™ graft material evenly throughout the achieved space



Placement of implant into the osteotomy

Lateral Approach (Sinus Elevation)

Wall-off Technique

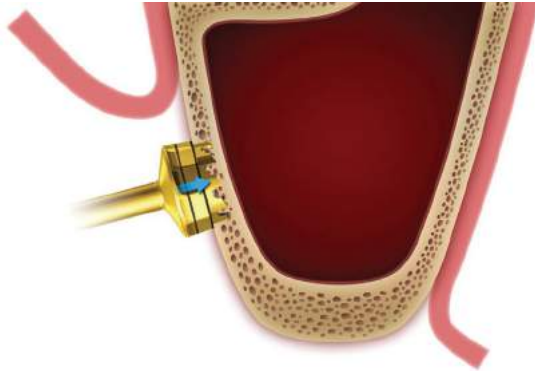

DASK Drill #6 is used to cut a round bony island from the lateral wall like a trephine bur. Start to drill at a desired location and proceed until you see the shadow of the sinus membrane. Then, separate and lift the bony island up from the neighboring wall with a molt curette or a periosteal elevator. The bony island is repositioned back in its original position after bone augmentation

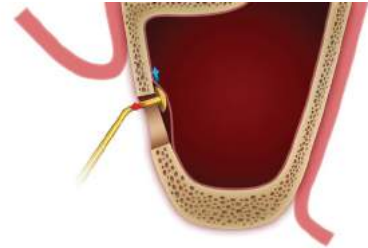

Detach sinus membrane using the dome-shape sinus curette

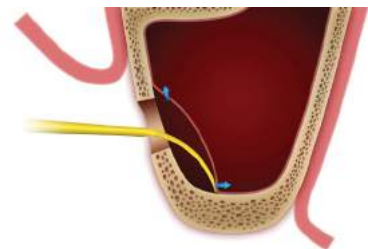

Elevate the sinus membrane to create adequate space for graft material

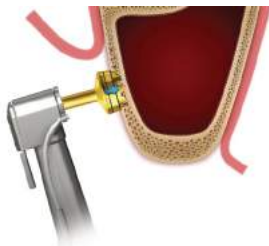

The first laser mark is 1.5mm and the second is 3.0mm. Overdrilling can cause sinus perforation and possible damage to the membrane

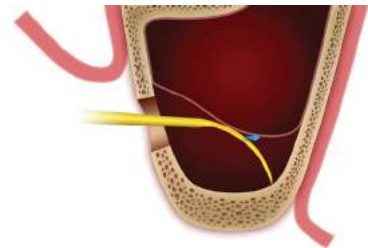

Elevate the sinus membrane to create adequate space for graft material

Thin-out Technique



Thin down the lateral wall with DASK Drill #4 or #5 at a 45 degree angle to reach the Schneiderian Membrane

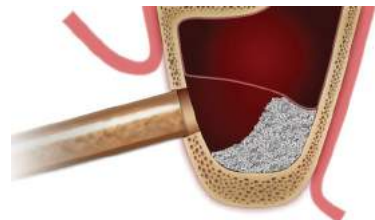

Fill the obtained space with [OSTEON™ Sinus] graft material

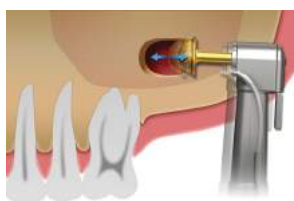

Move the DASK Drill #4 or #5 mesiodistally with a gentle pressure until you get the desired shape and size of the window for bone augmentation



The bony island can be repositioned after bone augmentation. [SuperLine] Implant placed

Osteotome Kit

- Osteotomes compress the bone laterally, providing denser bony interface rather than removing valuable bone from the surgical site

Osteotomes | Final drill type

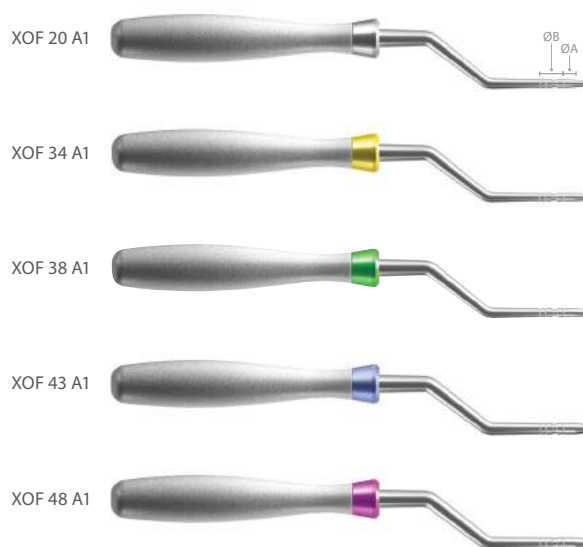

[Unit: mm, Scale 0.4 : 1]

Type A
(Convex)



Type B
(Concave)



Type	Art No	ØA	ØB
XOFK A (Convex)	XOFK 20 A1	Ø1.7	Ø2.8
	XOFK 34 A1	Ø2.3	Ø2.8
	XOFK 38 A1	Ø2.7	Ø3.2
	XOFK 43 A1	Ø2.8	Ø3.8
	XOFK 48 A1	Ø3.0	Ø4.3
XOFBK B (Concave)	XOFK 20 B1	Ø1.7	Ø2.8
	XOFK 34 B1	Ø2.3	Ø2.8
	XOFK 38 B1	Ø2.7	Ø3.2
	XOFK 43 B1	Ø2.8	Ø3.8
	XOFK 48 B1	Ø3.0	Ø4.3

Sinus Elevator

- Makes the sinus lift easy and drastically reduce the possibility of membrane perforation
- Balloon expansion of 0.5cc saline equals 6mm of membrane elevation



Type	Art. No.
Including Syringe	GSB 38
Balloon Only	GSB 38B

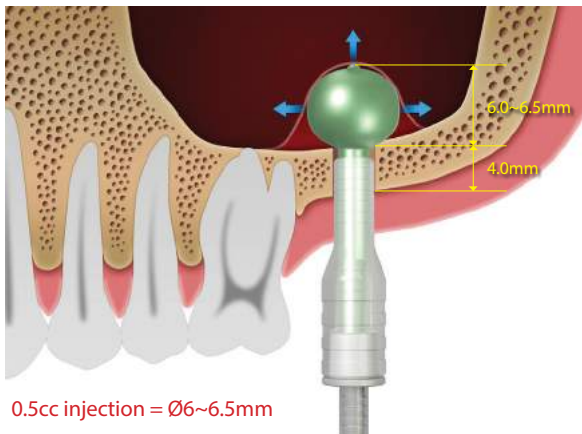
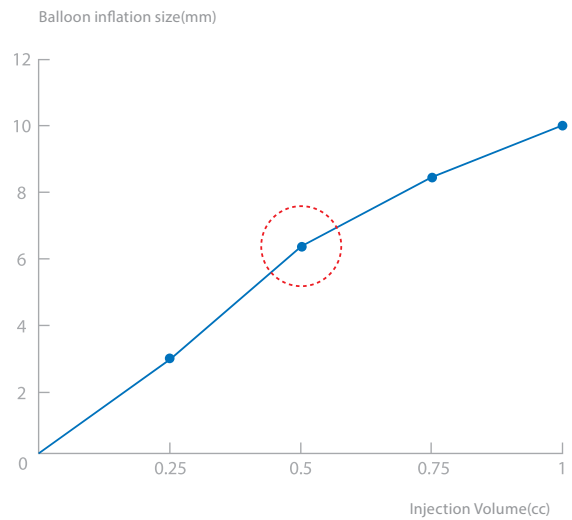

0.5cc injection = Ø6~6.5mm

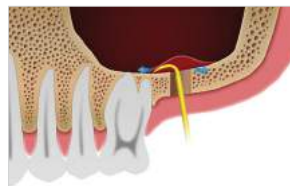

Detach the sinus membrane to create adequate space for graft material



Carefully insert the Sinus Elevator into the osteotomy

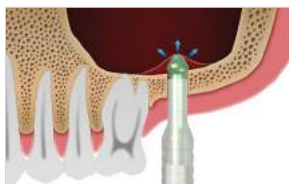

Expand the balloon progressively

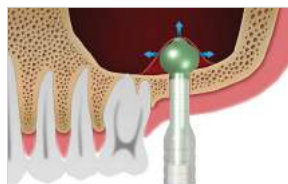

Elevate the sinus membrane through the balloon inflation



Use [OSTEON™ Lifting] graft material to fill the sinus cavity



Placement of implant in the osteotomy

GBR Instruments

*RS Kit
Harvest Drill*



Ridge Spreader (RS) Kit

- Allows the achievement of space for implantation through the spreading of the bone with chisel without drilling
- There are three types of Ridge Spreaders to create space up to $\text{\O}4.5\text{mm}$
- Convenient surgeries due to the compatibility with hand-piece and ratchet
- Easy-to-use kit component

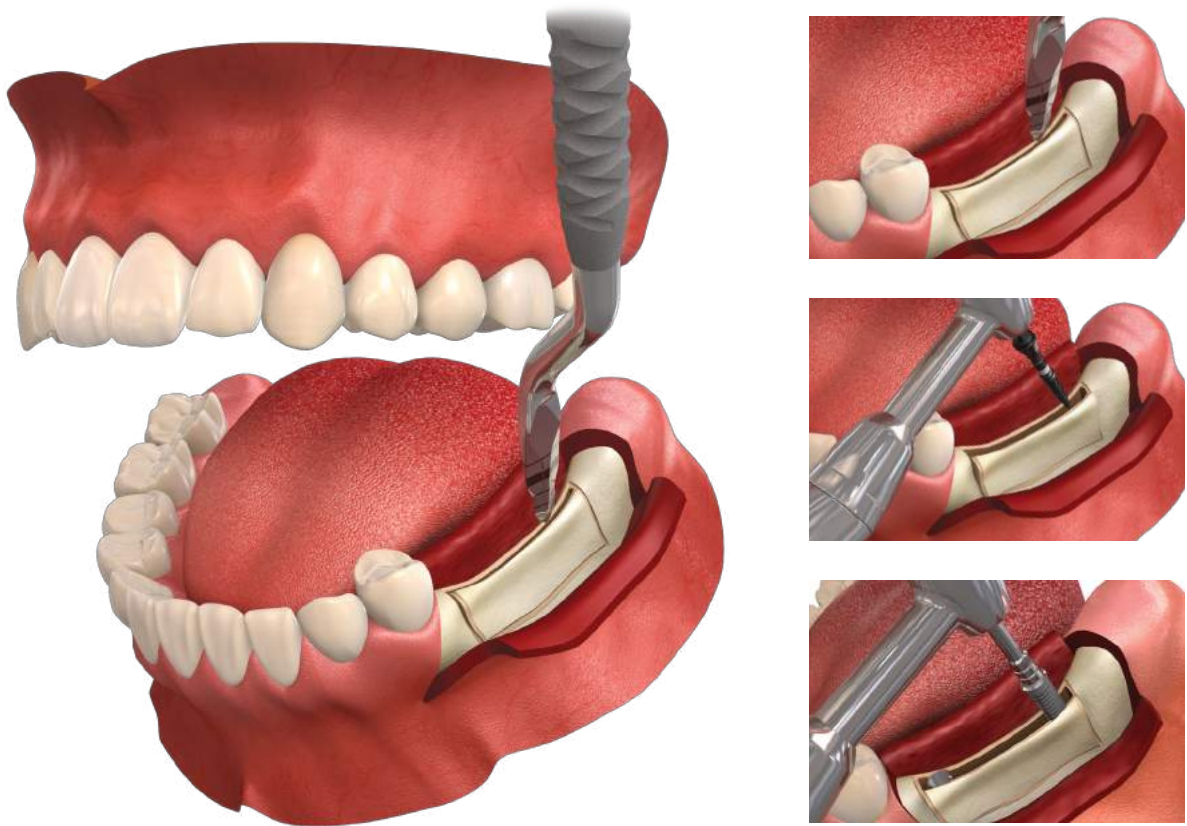

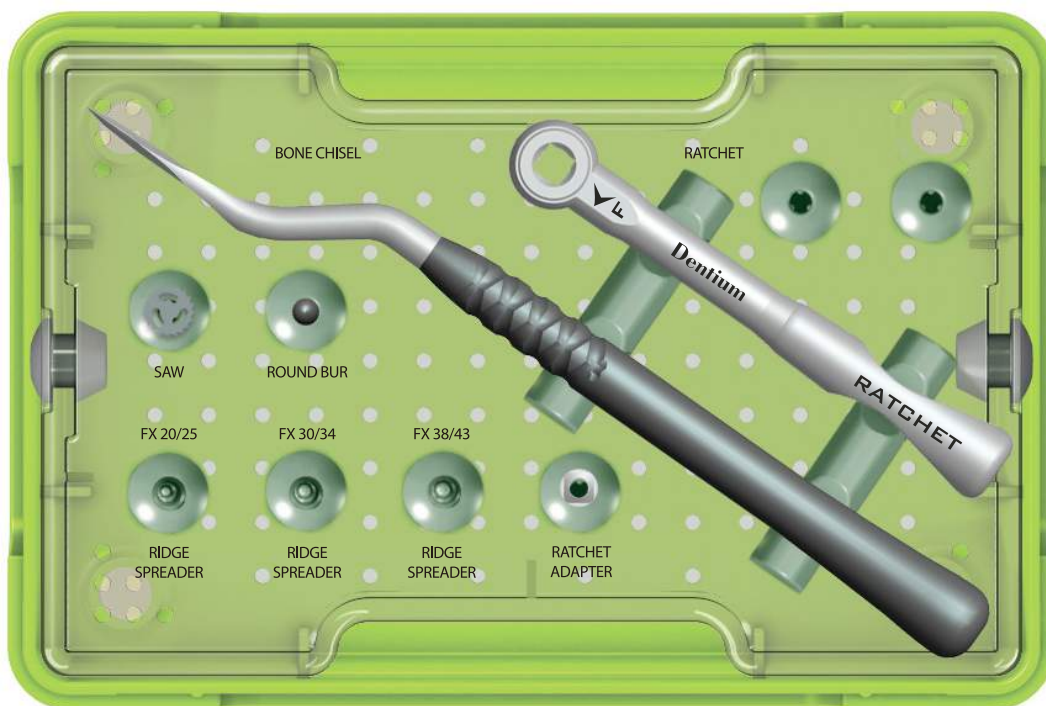

XRSK

Kit contents

Bone Chisel		XBC305013
Ratchet		XRCA1
Ridge Spreader Drills		RS142435
		RS203235
		RS263635
Round Bur		XRB4035
Ratchet Adapter		XRA3917
Mini Saw		XDS8025

Bone Chisel



Art. No.	XBC305013
----------	-----------

Ratchet



Art. No.	XRCA1
----------	-------

[Unit: mm, Scale 0.6 : 1]

Ridge Spreader Drills

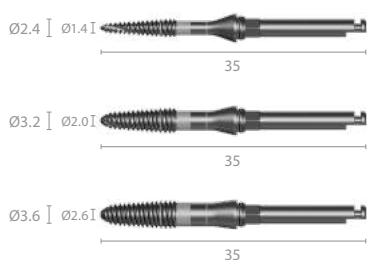

Diameter	L	Art. No.
$\varnothing 1.4$ / $\varnothing 2.4$	35	RS142435
$\varnothing 2.0$ / $\varnothing 3.2$	35	RS203235
$\varnothing 2.6$ / $\varnothing 3.6$	35	RS263635

Round Bur



Diameter	L	Art. No.
$\varnothing 4.0$	35	XRB4035

Ratchet Adapter



Art. No.	XRA3917
----------	---------

Mini Saw

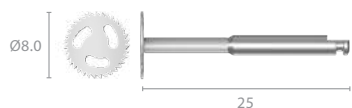

Diameter	L	Art. No.
$\varnothing 8.0$	25	XDS8025

[Unit: mm, Scale 1 : 1]

RS Kit + NR Line + OSTEON™ II + Collagen Membrane



Incision

Decortification

Expansion with Bone Chisel

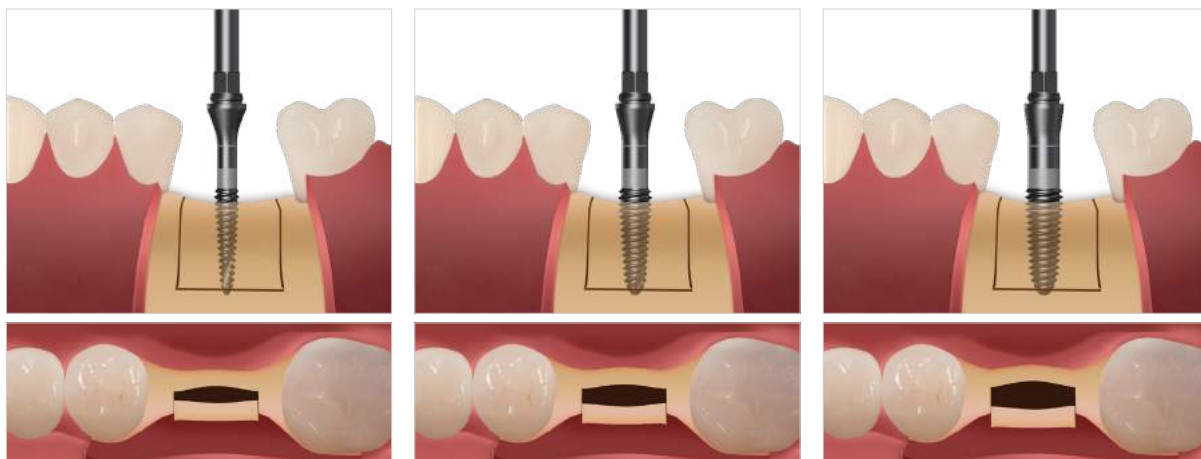

Expansion with Ridge Spreader (20~60rpm / 30~45N-cm) - Expanding alveolar bone ridge to make space for fixture

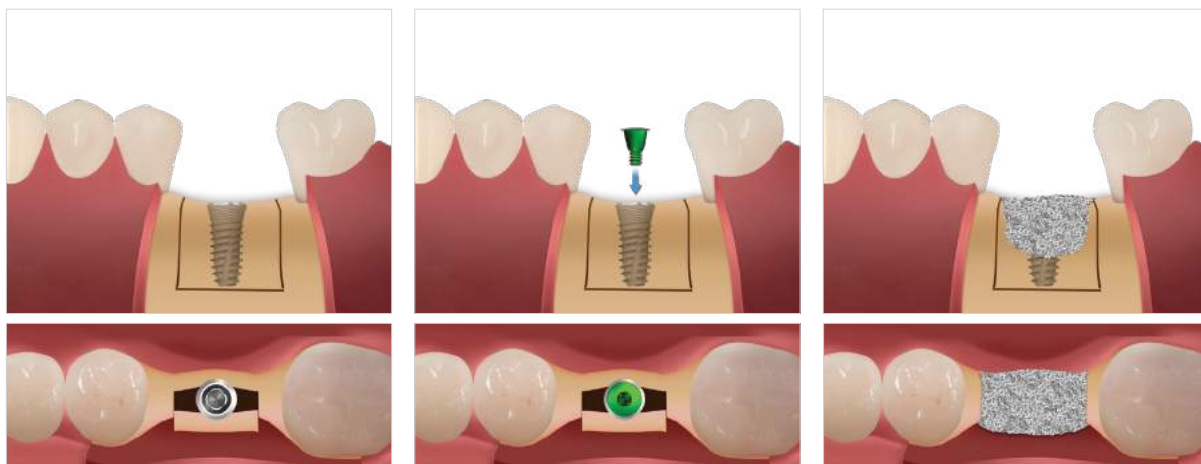

Fixture placement
NR Line

Cover Screw connection

Application of graft material
OSTEON™ II

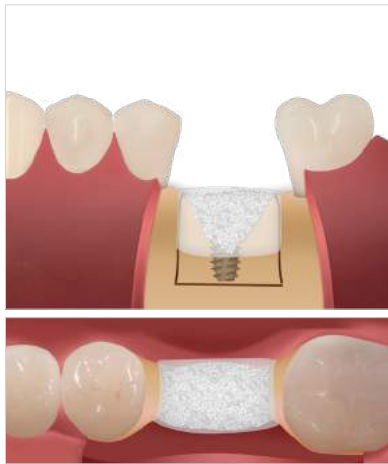

Barrier membrane application
Collagen Membrane

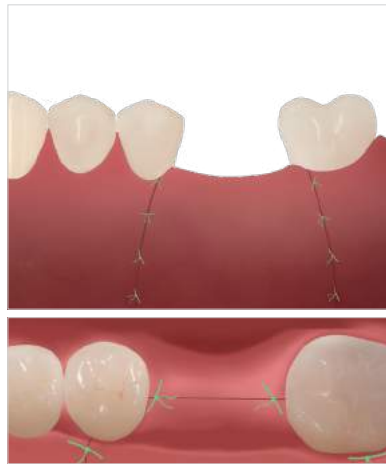

Suture

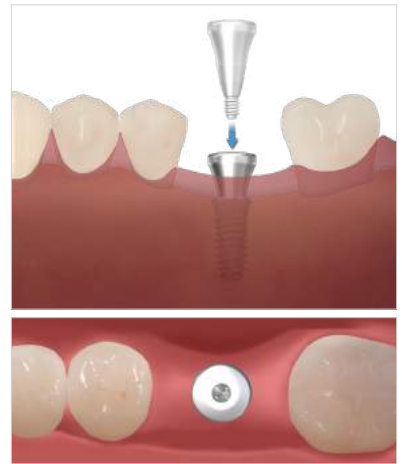

Healing Abutment connection



Dual Abutment connection



Final prosthesis

Harvest Drill

Collect autogenous bone and prep osteotomy simultaneously and effectively using the specially designed drills, the Harvest Drills

- Sharp, pointed tip to prevent drill chattering for precise drilling
- Drill stoppers applicable to control the depth of the drilling for safe and efficient bone harvesting, especially in the buccal side of the ridge
- Recommended drill speed of less than 100 rpm / 50N-cm helps preserve the vital autogenous bone
- Excellent clinical results may be achieved when harvested autogenous bone is combined with Osteon™ II

Harvest Drills

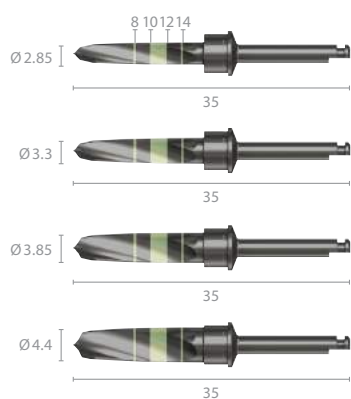

Diameter	L	Art. No.
Ø2.85	35	XFH 34 35
Ø3.3	35	XFH 38 35
Ø3.85	35	XFH 43 35
Ø4.4	35	XFH 48 35

Harvest Drill Stopper



Diameter	L	Art. No.
Ø6.14	15.9	XFHST04

First Guide Drill



Diameter	L	Art. No.
Ø2.2	35	XLD 22 35

Second Guide Drill



Diameter	L	Art. No.
Ø2.6	35	XLD 26 35

[Unit: mm, Scale 1 : 1]

* Bone collection in the buccal side of ridge: 50~200rpm / 30~50N-cm

Final Drill

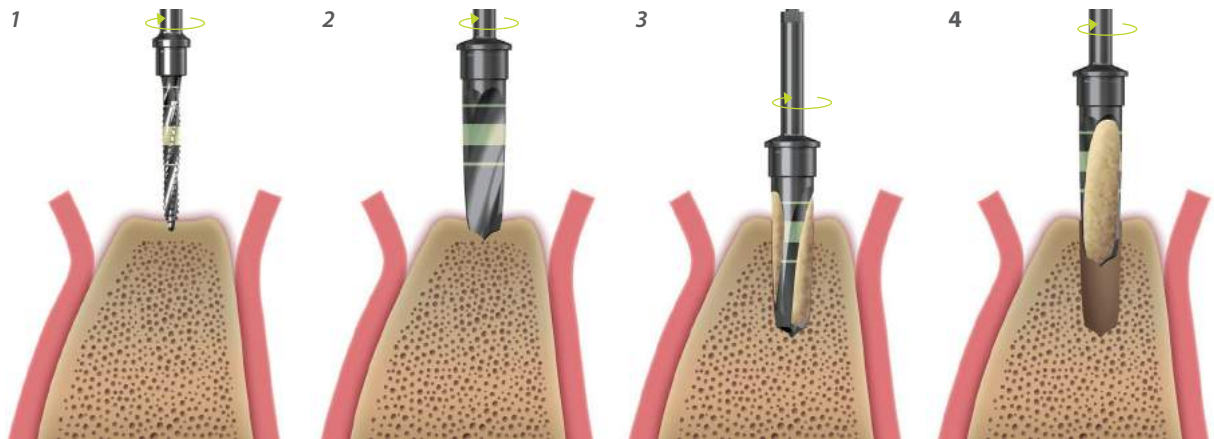

1 - First Guide Drill
1,000rpm/30~45N-cm with irrigation

2 ~ 4 - Harvest Drill
30~100rpm/30~50N-cm without irrigation

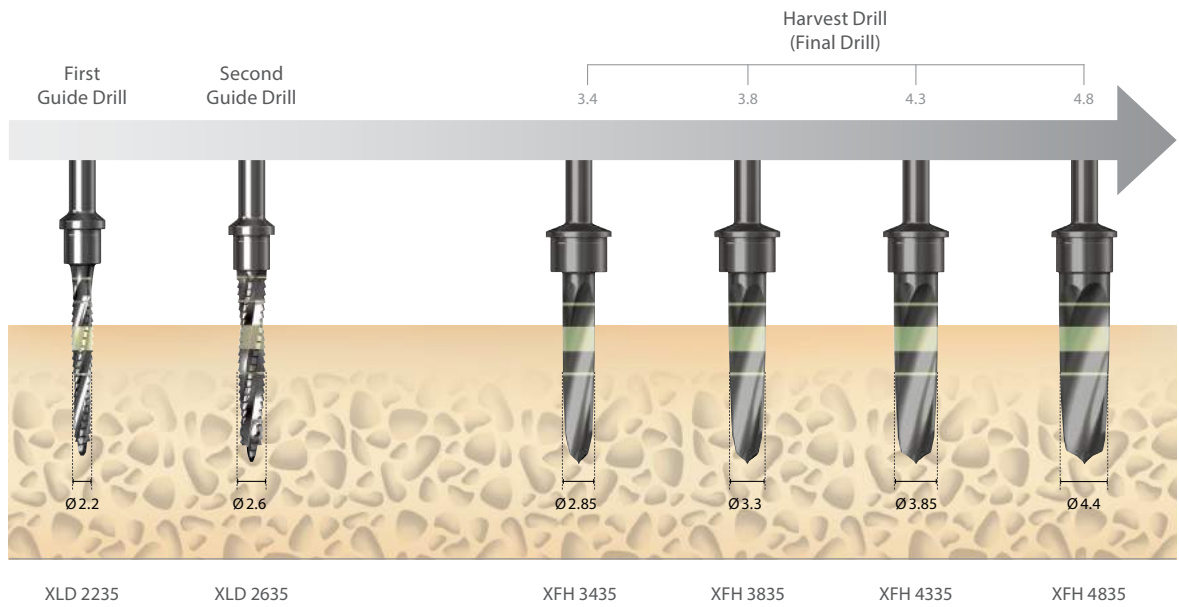

* During the 4.3/4.8 fixture insertion into the bone density of D3~D4, the 3.35/3.85 harvest drilling process can be skipped.



Others

Help Kit
Temporary Shell
White Seal
TN-Brush

Help Kit

- Easy solution for critical problems which may occur in the prosthetic process consist of 5 tools in a kit
- (Screw Remover/ Abutment Hex Remover/ Screw Tap Repair / Fixture Remover / Cover & Abutment Screw Remover)
- Compatible with most dental implant products now available on the global market
- Heavy duty with robust design and proven materials

SuperLine

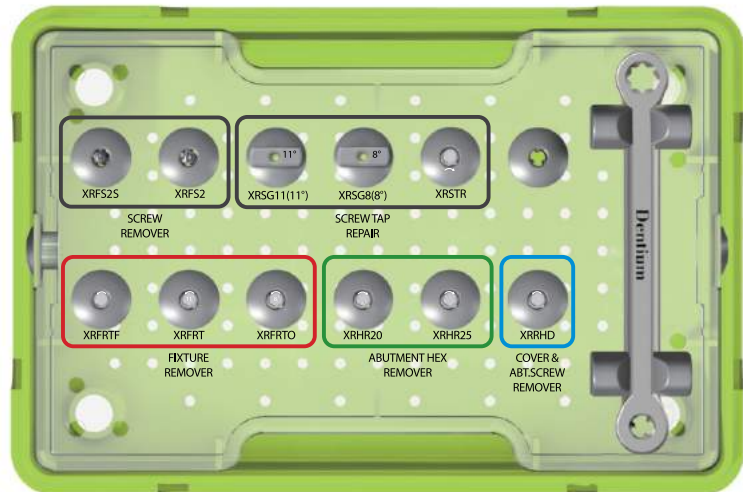

XIH

Screw Remover

L	Art. No.
25	XRF 52S
35	XRF 52

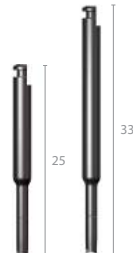

Abutment Remover

L	Art. No.
20	XRHR 20
25	XRHR 25

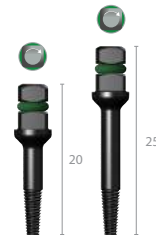

Screw Tap Repair

Type	Art. No.
Tap	XRSTR
11° Guide	XRSG11
8° Guide	XRSG8



Fixture Remover

Type	Art. No.
Remover	XRFRTF
	XRFRT
	XRFRT0
Wrench	XRFRW

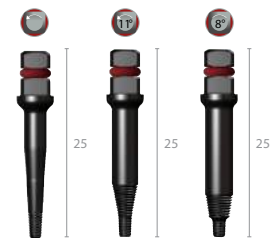

Cover & Abutment Screw Remover

L	Art. No.
25	XRRHD

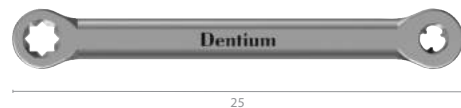

NR Lrne

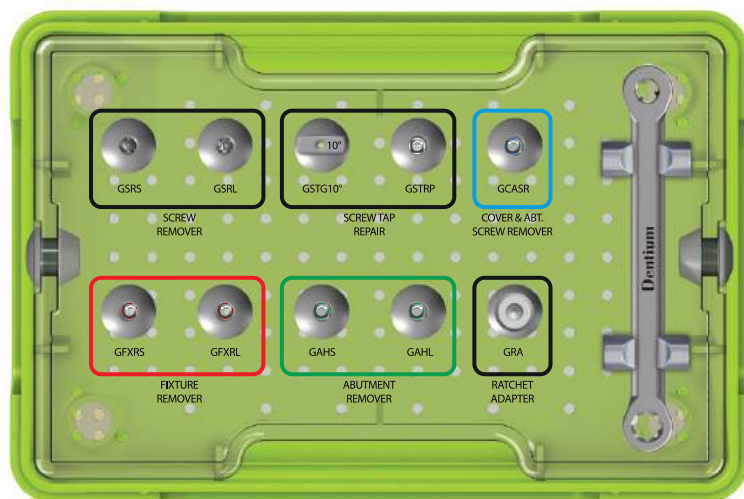

GXIH

Screw Remover

L	Art. No.
29	GSRs
33	GSRL



Abutment Remover

L	Art. No.
20	GAHS
25	GAHL

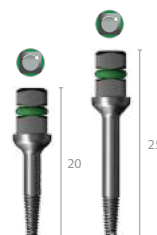

Screw Tap Repair

L	Art. No.
25	GSTRP
GUIDE	GSTG10



Fixture Remover

Type	Art. No.
25	GFXRS
30	GFXRL
Wrench	XRFRW

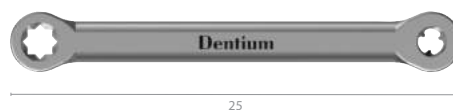
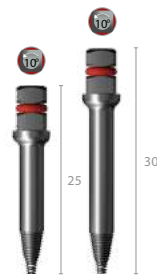

25

Cover & Abutment Screw Remover

L	Art. No.
25	GCASR



25

Ratchet adapter

L	Art. No.
13.9	GRA



13.9

Screw Remover

Application

To remove the remaining screw when the abutment screw is broken inside the fixture

Advantage

Easy to remove the broken screw, as well as protect the internal threads of the fixture from being damaged

Usage

1. Set the torque of the implant motor to 30~50 rpm in a CCW (counterclockwise) direction
2. Assemble the tool with the hand-piece
3. Run the motor while keeping the tip of the tool appropriately contacted with the broken screw until successfully removed

*Caution: Do not overload the tool with pressure; apply moderate pressure

1

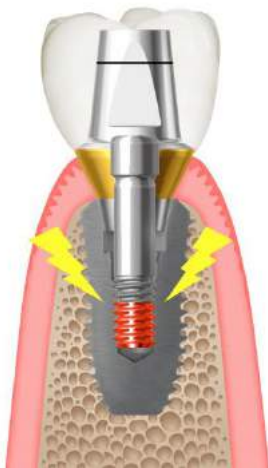

Dual Abutment

2

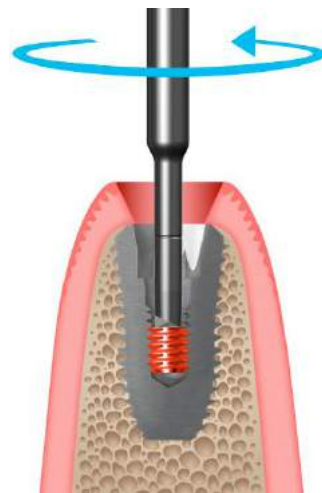

Use the friction force of the tool rotating counterclockwise to remove the screw

Hand-piece torque: 30~50rpm / Reverse

3

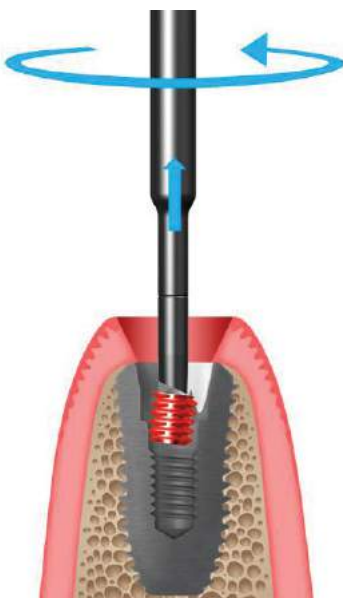

Allow the screw to gradually come out in a swaying motion

4



Abutment Hex Remover

Application

To remove the remaining hex when the hex portion of an abutment is broken

Advantage

Easy to remove the broken hex, as well as protect the internal threads of the fixture from being damaged

Usage

1. Insert the tool inside into the remaining hex hole of the fixture inside
2. Assemble the ratchet with the tool and rotate it in a CW (clockwise) direction to lock the tool tip with the remaining hex
3. Disengage the ratchet and remove the remaining hex by gently rocking the tool
4. If necessary, the hole located in the upper portion of the tool may be used with the crown ejector (not included)

*Caution: Do not overload the tool with pressure; apply moderate pressure

1

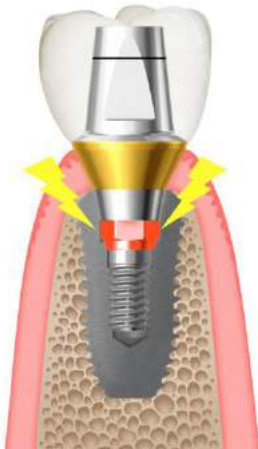

Dual Abutment (Hex)

2

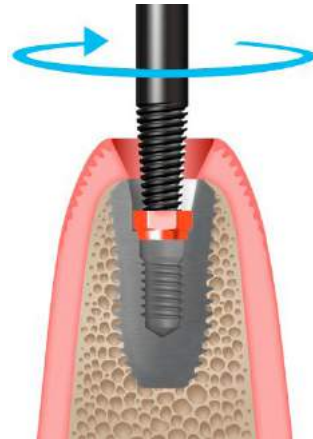

Rotate the tool clockwise so that the remaining hex gets tightly engaged to the tool

3

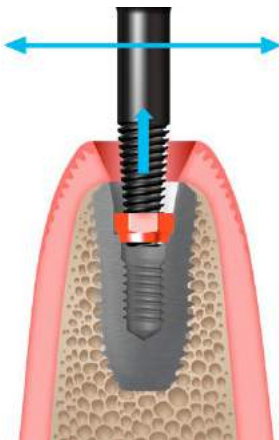

Once the tool is tightly locked to the hex remnant, disengage the ratchet
Gently rock the tool until the hex is successfully removed

4

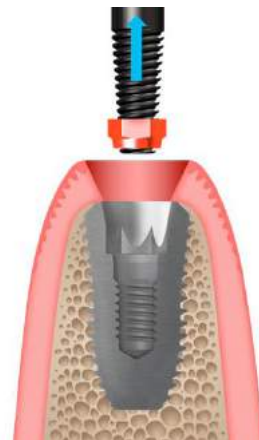

Screw Tap Repair

Application

To recreate the internal thread lines of the fixture when it is damaged

Advantage

Easy to recreate the internal threads with the help of the guides corresponding to different internal angulation (8, 11 degrees) of the fixture

Usage

1. Place the guide with corresponding degree to the fixture
2. Assemble the tap tool with ratchet
3. Start tapping using the tap tool with appropriate torque
4. If excessive debris accumulates, pause tapping and remove using suction
5. Repeat steps 3 and 4 until completed

*Caution: Do not apply excessive torque onto the tap tool

It is highly recommended to use the ratchet after the initial engagement of the tool and the internal threads

1



IMPLANTIUM / SuperLine 11°



SimpleLine II 8°

3



Tap with the guide attached

4



Remove the tool and the guide to suction the debris

*If excessive debris accumulates, pause tapping and remove using suction

Fixture Remover

Application

To remove the fixture when critically damaged with no other recovery options

Advantage

Easy to remove the failed fixture without causing damage to the adjacent bone

Usage

1. Assemble the tool with ratchet, and insert it into the failed fixture to be removed
2. Gently rotate the ratchet in a CCW direction until the tool is tightly locked into the fixture
3. Continue to rotate the ratchet with greater torque in a CCW direction until the failed fixture is completely removed
4. Separate the tool from the removed fixture by rotating it in a CW direction. If necessary, use the wrench (included) to hold the fixture while rotating the tool with ratchet in a CW direction

*Caution: Sufficient irrigation should be applied to the tool to prevent excessive heating during the procedure

1 Art No. XRFRT



IMPLANTIUM / SuperLine 11°

Art No. XRFRT0



SimpleLine II 8°

2~3



Rotate the tool in a counter clockwise direction until it is tightly locked into the fixture. Continue to rotate with additional torque until the failed fixture is completely removed

4



Separate the tool from the fixture using the ratchet and the wrench that are included in the kit

Cover & Abutment Screw Remover

Application

To disengage the cover screw, healing abutment and abutment screw from the fixture when the 1.28 hex on the head is stripped or damaged

Advantage

Easy to disengage the cover screw, healing abutment and abutment screw with stripped or damaged hex

Usage

1. Assemble the tool with the ratchet and place it over the damaged 1.28 hex of the cover screw, healing abutment or abutment screw that needs to be removed
2. Gently rotate the ratchet in a CCW direction to tightly engage the tapered top of the tool into the damaged 1.28 hex.
3. Continue to rotate the ratchet in a CCW direction with greater torque until the cover screw, healing abutment or abutment screw is completely removed
4. After the removal, rotate the ratchet in a CW to separate the tool and the removed component

1 Cover Screw

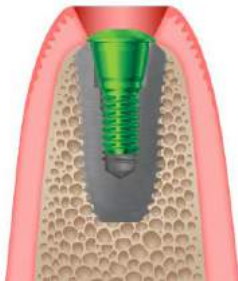

2 Loading downward



Rotate the tool counterclockwise until tightly locked into the 1.28 hex of the cover screw

3 Abutment Screw

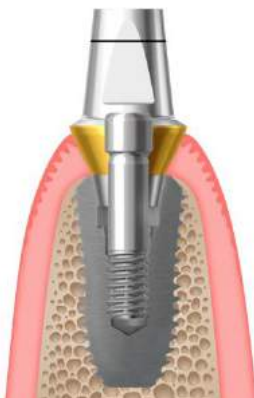

4 Loading downward

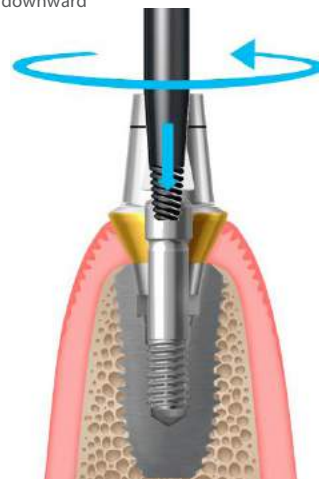

Rotate the tool counterclockwise until tightly locked into the 1.28 hex of the abutment screw

Temporary Shell

Preformed Temporary Crown

- Esthetic appearance that mimics a natural tooth
- Convenient for both single and multi-unit restoration

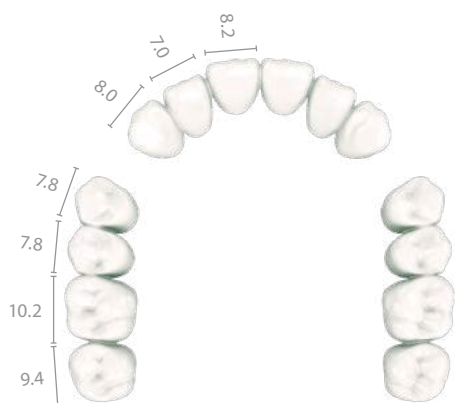

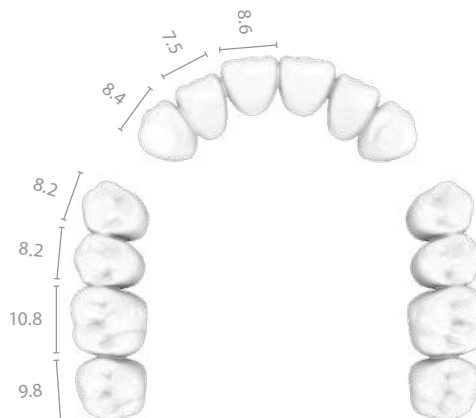

A2 Shade

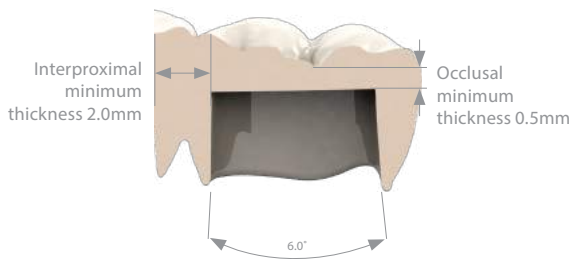
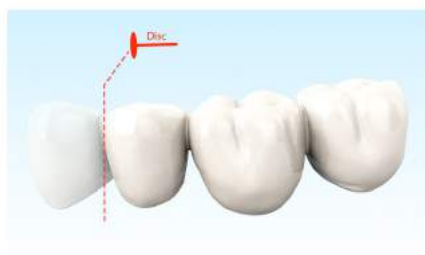
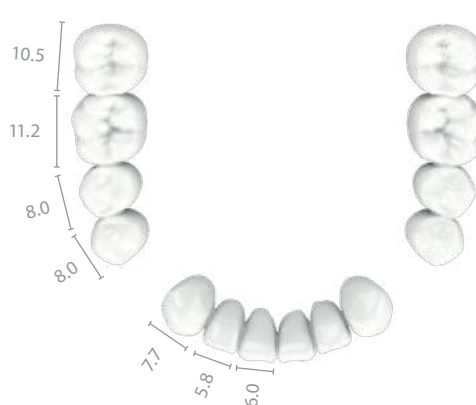
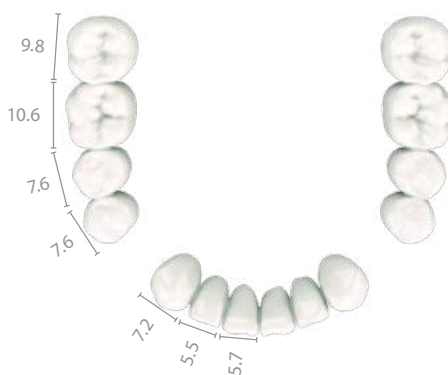

Transparent



Shade		Type	REF
	A2	Full set	TSA2-FS
	Trnsparent	Full set	TSTR-FS



Healing

Temporary Abutment connection

Temporary Abutment preparation

Temporary Shell try-in

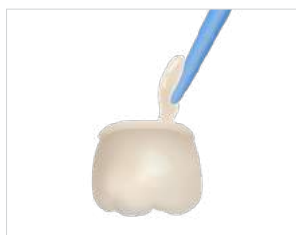

Filling of the Temporary Shell with acrylic Resin



Placement of Temporary Shell

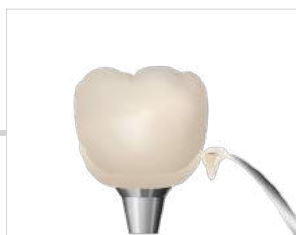

Contouring of the cervical crown margin



Placement of Temporary Shell



Healing



Temporary Abutment connection



Temporary Shell try-in



Filling of the Temporary shell with acrylic resin



Acrylic resin setting



Contouring of the cervical crown margin



Contoured restoration



Provisional restoration

White Seal

Easier filling and removal

- Unlike the conventional cotton or impression material, the plush material allows a greater user-friendliness during dental procedures

No odor & color change

- Odor and color changing problem seen in Silicone or other sealing materials is eliminated

Stable form maintenance

- The rod with proper stiffness helps maintain its form while preventing the upper application layer from collapsing

Easy to fill into the screw hole

- White Seal™ is available in 30mm (length) size. The user may easily cut off the desired length and conveniently store away the rest for later use

Color / Odor Change Test



Products

Diameter	Length	Art. No.
Ø1.9	30	AHF 19030
Ø2.3	30	AHF 23030



How to use

Cut off a piece of the White Seal™ in the desired size with scissors or a knife.
Insert the piece into the abutment hole and seal it with a resin material.
(*It is recommended to submerge the White Seal™ 2.0mm from the occlusal surface.)

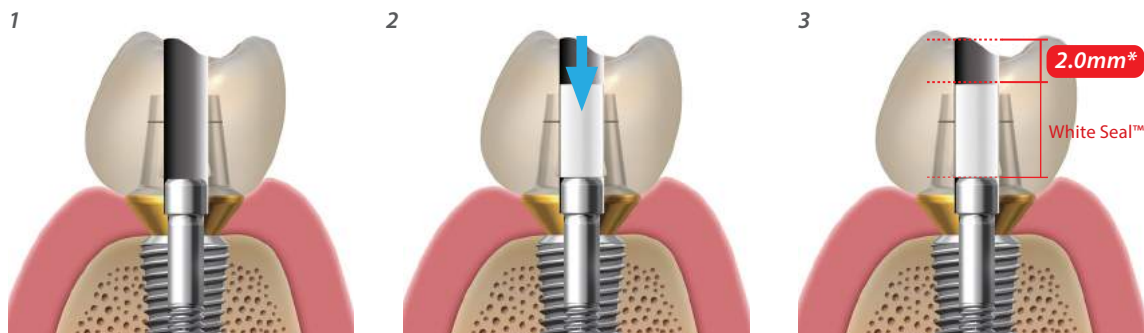

White Seal™



Hole resin filling



After 15 months

White Seal Tool

Depth Gauge & Delivery Holder

XSWN



XSWS



Remover

XSWR



Application	Art. No.
NR Line	XSWN
SuperLine, Implantium, SimpleLine II	XSWS

Application	Art. No.
Use common	XSWR



Delivery Holder



Depth Gauge

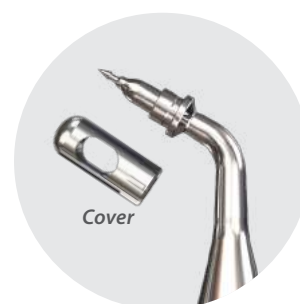

Remover

1 Cutting the White Seal™

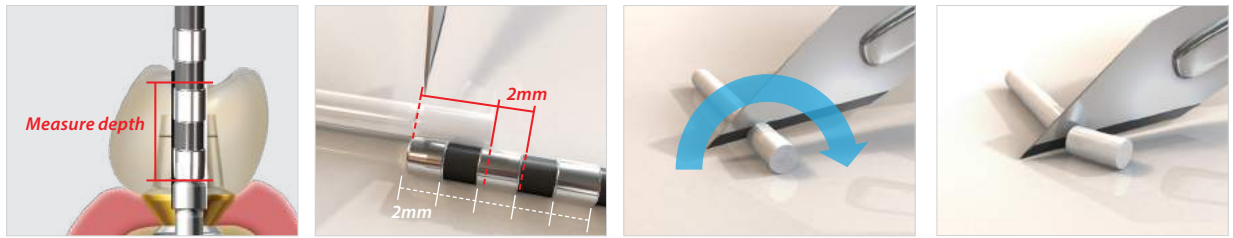

2 Delivery the White Seal™ (Delivery holder)

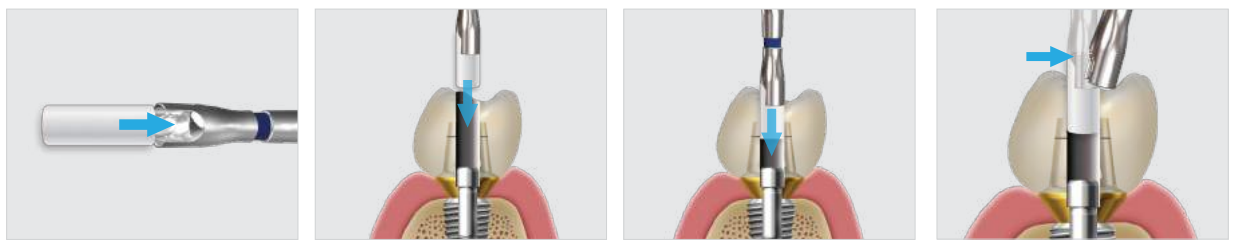

3 Delivery the White Seal™ (Depth gauge)

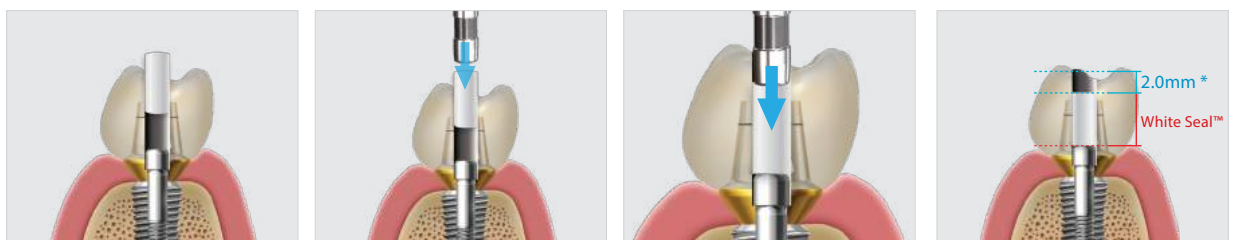

4 Removal of the White Seal™ (Remover)

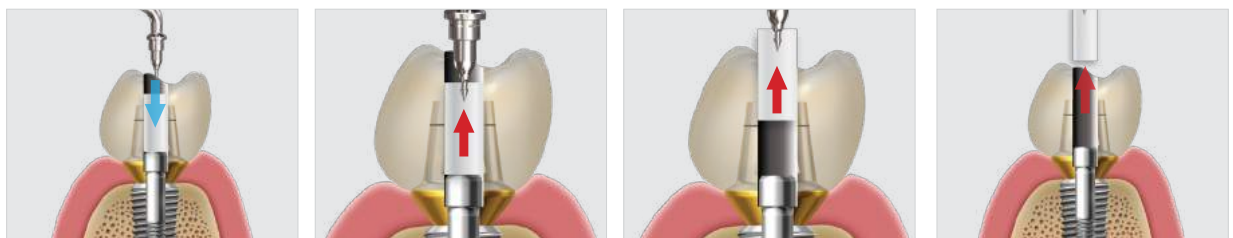

TN-Brush

- Remove plaque and granulation tissue around the fixture using spinning brush
- The force of shape restoration is excellent with chosen highly elastic brush



Use brush left to right or top to bottom
500~800 rpm with irrigation

Brush

Diameter	Art. No.
Ø0.8	TN-0.8
Ø1.0	TN-1.0



[Unit: mm, Scale 2 : 1]

Manual

case 1 _ Peri-implantitis

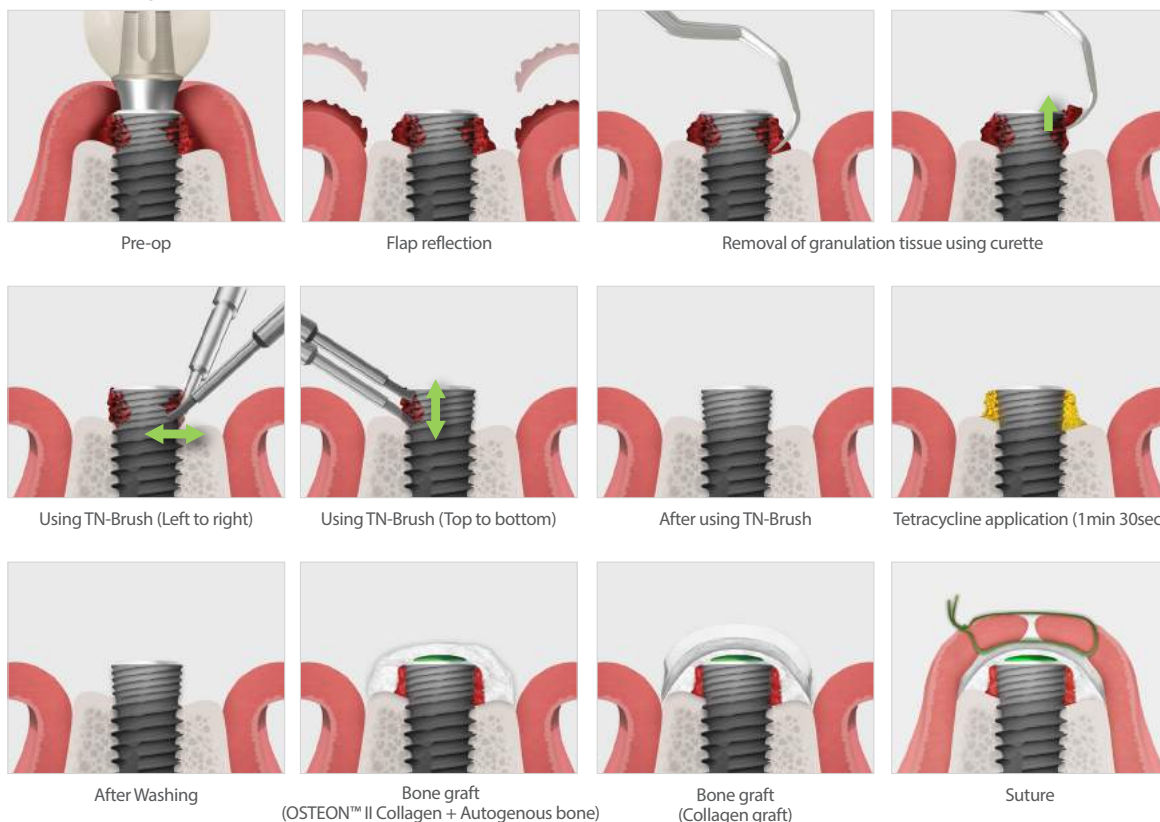

case 2_Perio-implantitis



Pre-op



Removal of granulation tissue using curette



Using TN-Brush (Left to right)



Using TN-Brush (Top to bottom)



After using



Healing

Case 3_Perio-implantitis



Pre-op

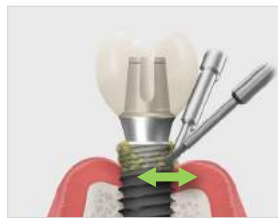

Using TN-Brush (Left to right)



Using TN-Brush (Top to bottom)



After using TN-Brush

Case 4_Periodontal treatment



Flap reflection



Root planning in open treatment

SEM

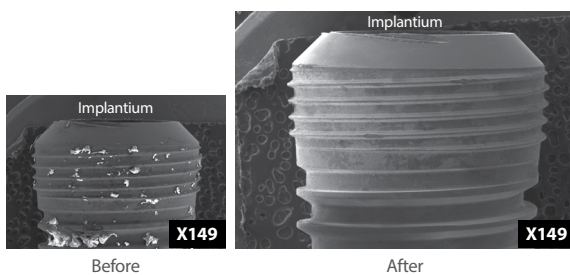

Before

After

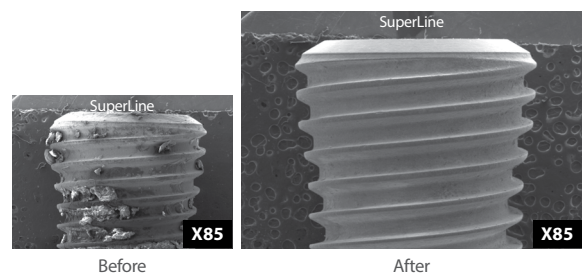

Before

After

DENTIUM LONG-TERM CLINICAL DATA

2002

2003

2004

2005

2006

2007

2008

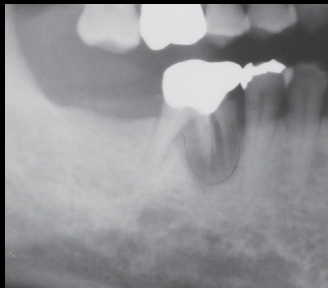

2002. 05. 17
Pre-op

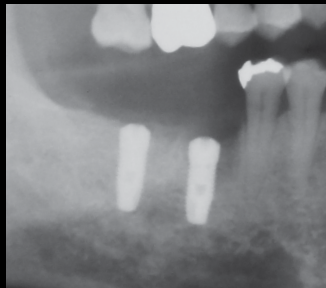

2002. 09. 04
Post-op



2003. 03. 15
Final prosthesis

Dentium

For Dentists By Dentists

2009

2010

2011

2012

2013

2014

2015

11 YEARS



2008. 04. 14
5 years

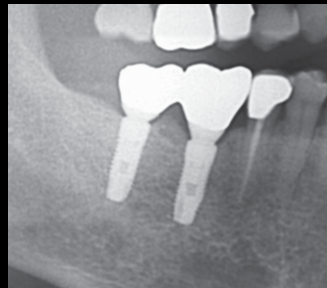

2013. 12. 05
11 years

over
10 years
of Long
term
data

OVER A **DECADE** OF
COMMITMENT TO
THE **BEST PRODUCTS**
FOR DENTISTS AND
PATIENTS

Dentium
For Dentists By Dentists

Dentium
For Dentists By Dentists

Dentium Instruments

for Total Solution

Catalog & Manual

Dentium
For Dentists By Dentists

Specifications are subject to change without any notice.
Some products listed in this catalog are not available in the market due to pending approval.

HEAD OFFICE
6F, 29, Teheran-ro 87-gil, Gangnam-gu, Seoul , Korea (135-879) Tel +82-2-555-3750 Fax +82-2-501-9560
HOME PAGE
www.dentium.co.kr

INCO-1603 [Rev.1]